



ENDO ESSENTIALS

ENDODONTIC PRODUCT CATALOG

*Hu-Friedy proudly supports
endodontic research and education
through the American Association
of Endodontists Foundation.*

How the best perform





SOLUTIONS OVERVIEW



Since 1908 Hu-Friedy has been putting the highest quality, innovative dental products in the hands of dental professionals worldwide. And today as one of the world's leading dental instrument companies, we continue our commitment to advancing dental performance by supporting these products with world class service, support, education and peer communities. We're committed to making sure the best perform that way.

Hu-Friedy. How the best perform.

A Worldwide Focus on Quality

Hu-Friedy is based in Chicago and has been privately owned by the Saslow family since 1959. Today we employ over 600 talented and committed employees in more than 25 countries – including our production facilities in Chicago and Shanghai, China; our distribution centers in Niles, Illinois, and Tuttlingen, Germany; and our additional offices in Japan, Germany, Italy and the Netherlands. Worldwide, our products are sold in more than 95 countries.

Our mandate for excellence is company-wide. Only at Hu-Friedy will you find more than 300

artisans meticulously handcrafting instruments in a modern manufacturing facility. Only here are employees personally responsible for the quality of their work and each other's. We believe that our success is the result of both our company's commitment to excellence and the dedication and pride of our highly skilled instrument craftspeople, management and staff.

A Legacy of Innovation

Since the Hu-Friedy Manufacturing Company was founded in 1908 by Hugo Friedman, we have proudly collaborated with private practitioners, dental schools and leading educators to develop

new technologies, innovative designs and quality products that are synonymous with value and performance. Because of our reputation for industry leadership, dental experts have been turning to Hu-Friedy with their cutting-edge ideas for over a hundred years.

From our inception, we have been committed to education and developing relationships with students. At the core is our commitment to helping our customers perform at their best and to improve lives through better dentistry. From student to practitioner, Hu-Friedy is proud to be an important part of our customers' professional lives.

How the best perform





HU-FRIEDY'S ENDODONTIC INSTRUMENTATION

Hu-Friedy's comprehensive line of endodontic instruments and accessories give you versatile options to meet all of your clinical needs. Many of our instruments, especially those made for microsurgical applications, were developed in conjunction with leading global Key Opinion Leaders who are on the cutting-edge of clinical research, design and application. If you are looking for exceptional instrument design, quality and reliability, and unmatched customer service, choose Hu-Friedy's Endodontic Instruments.

The Challenge

The sensitive nature of endodontic procedures necessitates instruments with exceptional response, integrity and durability to accommodate a wide variety of endodontic procedures – from routine root canals to complex microsurgery.

The Solution

Hu-Friedy instruments are individually handcrafted to precise specifications from quality materials to ensure superior performance, longevity and reliability. Instrument design combined with proprietary materials and incomparable workmanship result in instruments with unique balance, working leverage and control. They function as a seamless extension of the practitioner's skill.

The Result

High-quality Hu-Friedy instrumentation provides unsurpassed clinical efficiency, so practitioners can deliver superior outcomes and focus on the patient. The result is outstanding patient care.

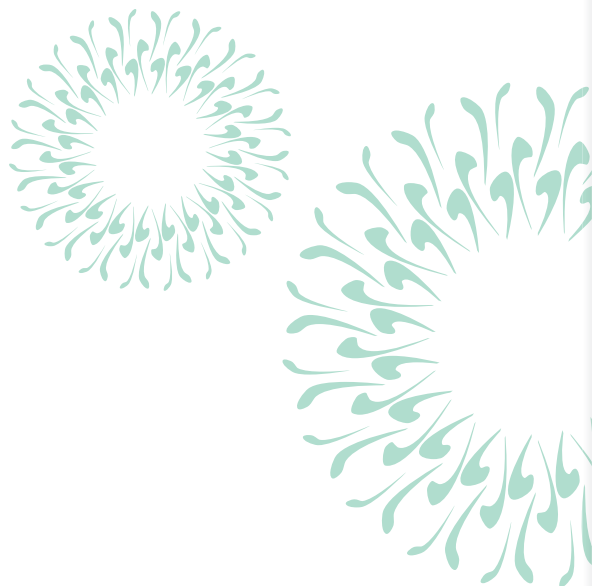

TABLE OF CONTENTS

Endodontic Introduction	3
Endodontic Microsurgery	4
Surgical	13
Explorers	16
Excavators	17
Endodontic Accessories	18
Spreaders	19
Pluggers	22
Rubber Dam Clamp Accessories & Kits	25
Rubber Dam Clamps	27
Instrument Management System (IMS®)	31
Key Opinion Leader Kit Lists	35



ENDODONTIC MICROSURGERY

Hu-Friedy has an extensive line of apical hand instruments. This includes curettes, explorers, condensers, burnishers and mirrors. Many were developed in conjunction with Hu-Friedy Key Opinion Leader, Professor Marwan Abou-Rass and other leading global innovators.

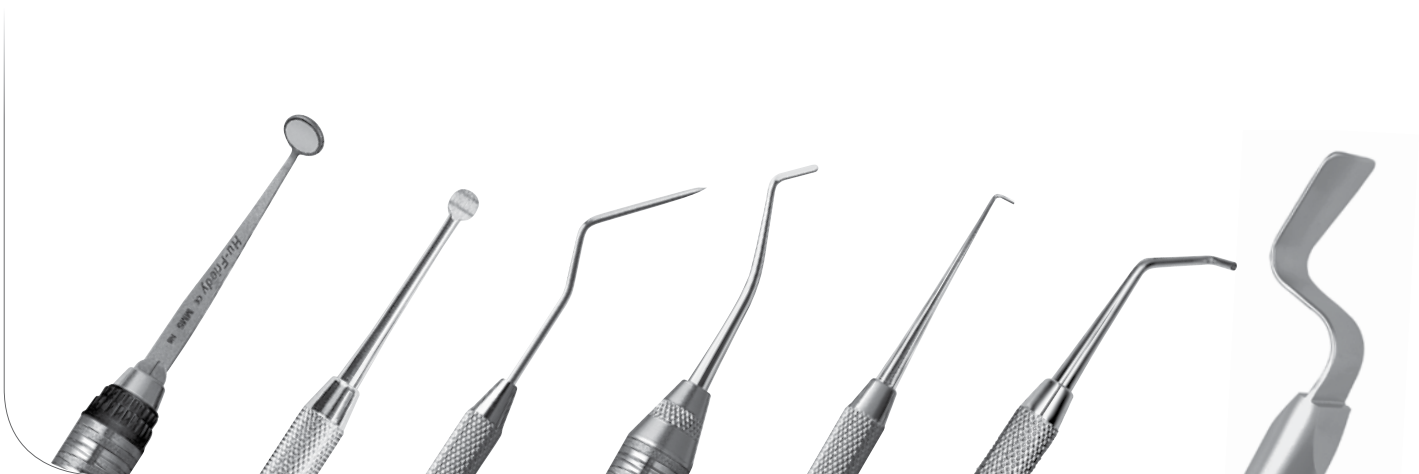
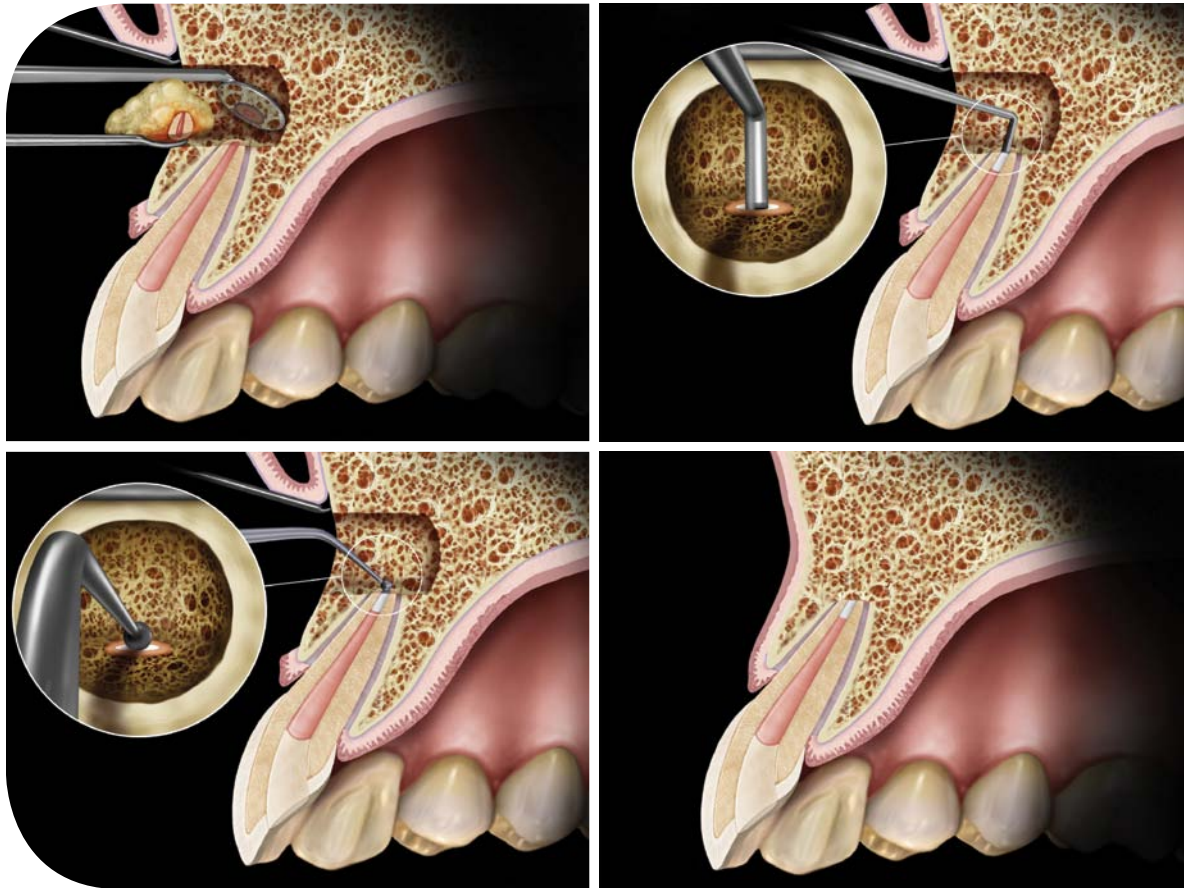

Mirrors

Curettes/
Excavators

Explorers

Filling
Instruments

Condensers/
Pluggers

Combo Plugger/
Burnisher

Retractors



MICROSURGICAL MIRRORS

Hu-Friedy has a large assortment of microsurgical mirrors to choose from. They are made from highly polished stainless steel, come in round or rectangular shapes, are single or double-ended, and are offered in a variety of sizes. Select from single instruments or choose the mirror you want and team it up with a handle of your choice. The rhodium-coated front surface mirrors offer sharp, scratch- and distortion-free visibility.

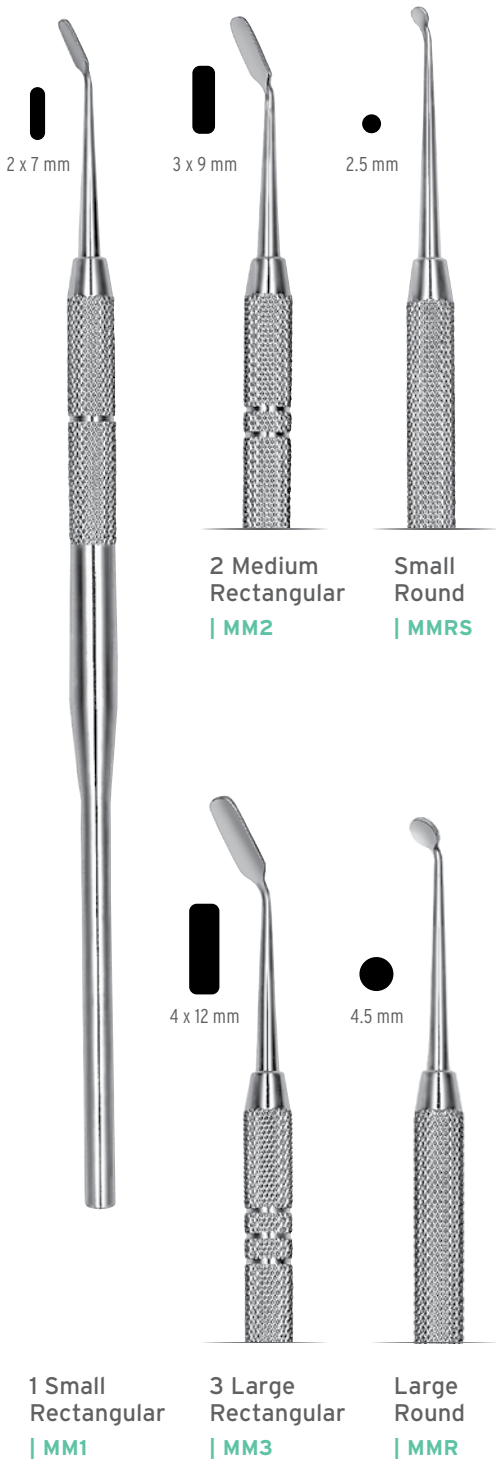

FRONT SURFACE RHODIUM-COATED



VELVART

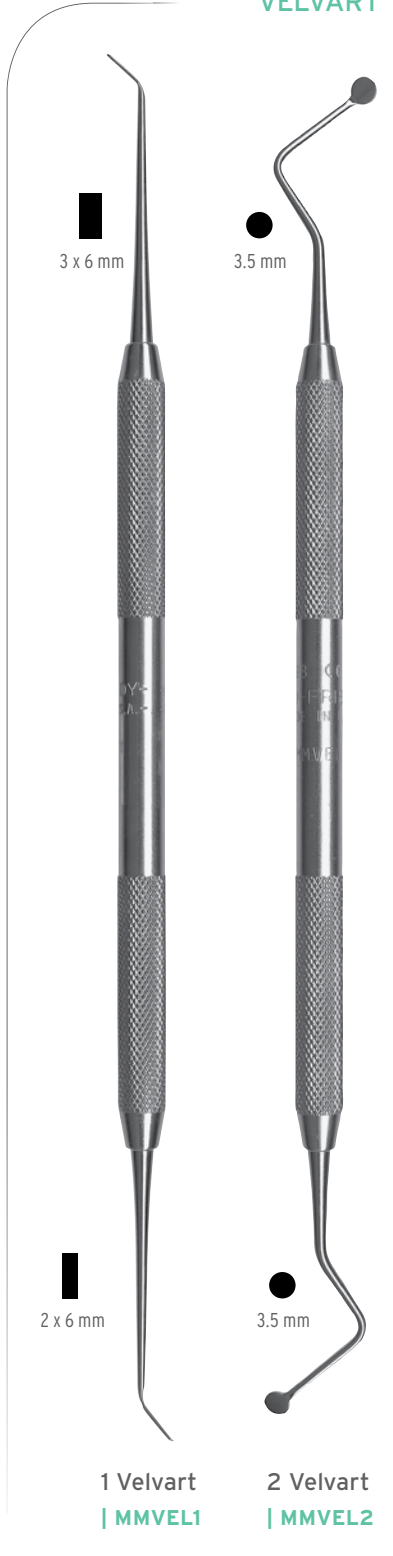

*Handle sold separately. MBW wrench required for assembly.

Handles of the MM1, MM2 and MM3 are marked with one, two or three bands for easy identification.

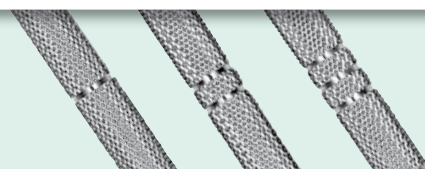



MICROSURGICAL ABOU-RASS CURETTES/EXCAVATORS

Curettes in straight and angled forms, and useful sizes. Straight curettes provide controlled straight line access and good visibility; use angled forms to access difficult or confined areas.

STRAIGHT



1.5 mm

1 Abou-Rass Apical
| MAR-SC1



2.5 mm

2 Abou-Rass Apical
| MAR-SC2



3 mm

3 Abou-Rass Apical
| MAR-SC3



4 mm

4 Abou-Rass Apical
| MAR-SC4

ANGLED



1 mm

1 Abou-Rass
| MAR-C1



2 mm

2 Abou-Rass
| MAR-C2



3.2 mm

3 Abou-Rass
| MAR-C3



4 mm

4 Abou-Rass
| MAR-C4

*The terms "Curettes" and "Excavators" are interchangeable.



Hu-Friedy's large selection of microsurgical explorers are available in various designs and working ends, giving the clinician useful options for exploration and treatment. From the basic and popular MEX1, to Professor Abou-Rass' excellent assortment of explorers, they all provide the balance, fine design and construction that practitioners need for careful yet thorough apical exploration.

DOUBLE-ENDED

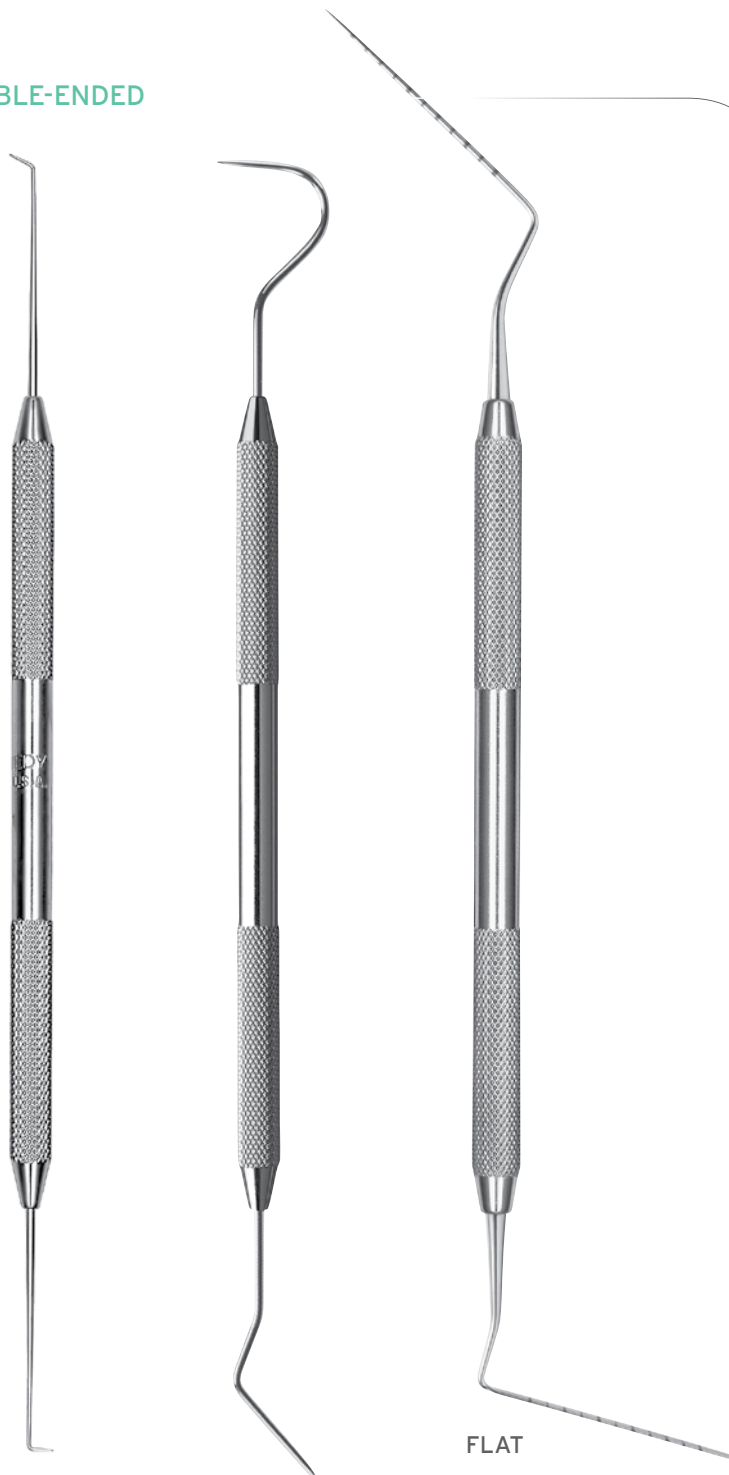

Explorer | MEX1
A popular, basic apical explorer used to initiate the tracking groove in the root tip, and for general exploration and probing.

1 Abou-Rass | MAR-EX1
A versatile explorer with two different, useful and sharp working ends.

3 Abou-Rass | MAR-EX3
A probe with one blunt flat and one round end; excellent for taking measurements, especially the direct root length of the apex.

SINGLE-ENDED



2 Abou-Rass | MAR-EX2
A single-ended bone file styled explorer used to enlarge the opening made by MAR-EX1 into the cortical bone to allow drainage.

4 Abou-Rass | MAR-EX4
Its straight, sharp working end is ideal for penetrating small osseous defects in cortical bone.



5 Abou-Rass | MAR-EX5
A 45° angled explorer used to check dentinal defects, such as root caries, root resorption and fracture lines.

6 Abou-Rass | MAR-EX6
A 90° angled, sharp-pointed explorer useful for detecting apical foramen and apical seal quality.



MICROSURGICAL FILLING INSTRUMENTS & PLUGGERS

RETROFILLING

Hu-Friedy has several double-ended apical filling instruments to choose from, including the recently launched filling instrument developed in conjunction with Dr. Bertrand Khayat, a Hu-Friedy Key Opinion Leader.



Khayat
| PF18ABK6
This versatile Khayat filling instrument has one angled and one straight spatula end. Useful for complex, deep apical treatments.

Left Apical
| MRFL
The left of two paired instruments that are used for filling, condensing and burnishing.

Right Apical
| MRFR
The right of two paired instruments that are used for filling, condensing and burnishing.

PLUGGERS

These pluggers give the clinician very different working ends for enhanced maneuvering and versatility.

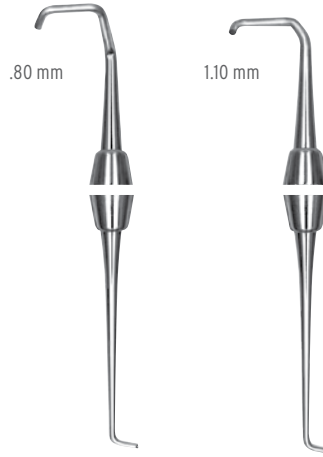

1
| PLGRF1

2
| PLGRF2

The Khayat and Velvart pluggers are useful for deep canal condensation, and can be used together for this purpose. Designed in conjunction with Dr. Bertrand Khayat and Dr. Peter Velvart.



Khayat
| PLGBK6

Velvart
| PLGVEL56

MICROSURGICAL ABOU-RASS CONDENSERS/PLUGGERS



Designed in conjunction with Professor Abou-Rass, these double-ended instruments are perfect for retrofill applications. They are double-ended with one round and one oval tip. Round working tips produce "pot hole" preparations while oval tips make "isthmus" designs.

STRAIGHT

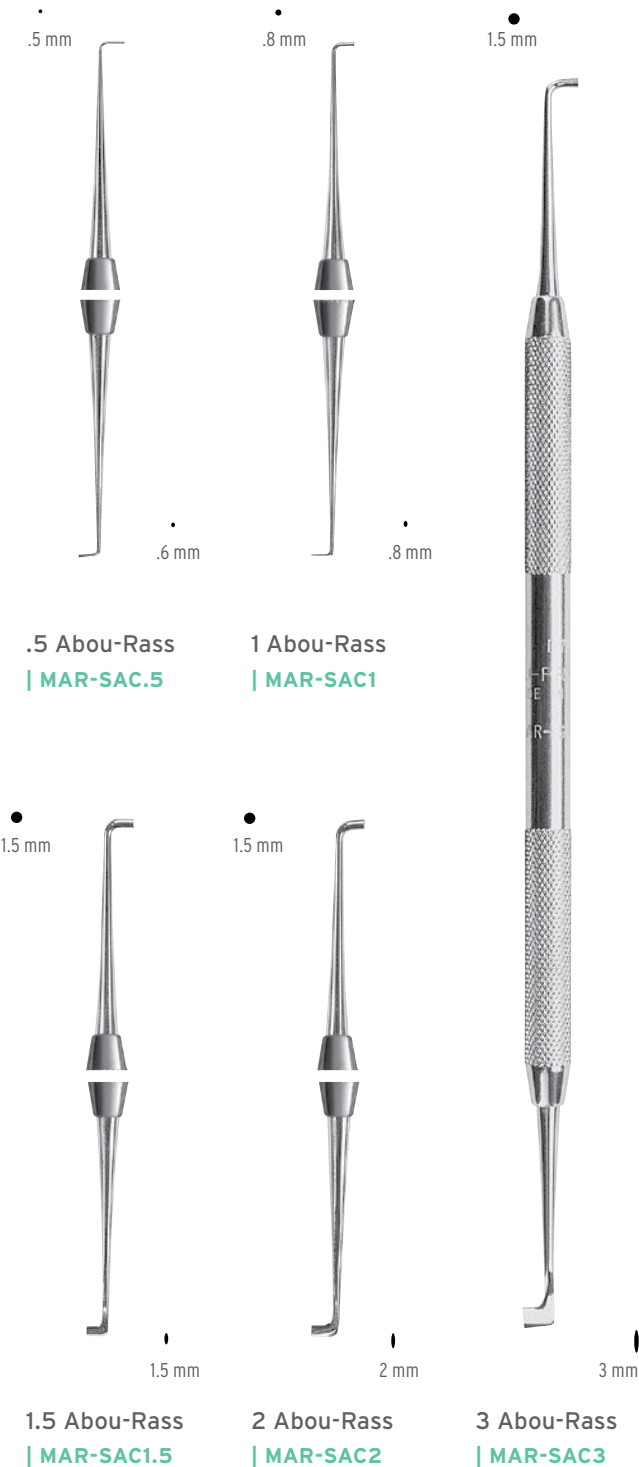

ANGLED



*The terms "Condensers" and "Pluggers" are interchangeable.



MICROSURGICAL CONDENSERS/BURNISHERS

These versatile double-ended instruments combine a condenser on one end and a ball burnisher on the other end. The plugger ends feature universal, right and left designs and come in small, medium and large sizes.



Large Left
| MCBLL



Large Right
| MCBRL



Medium Right
| MCBRM



Medium Left
| MCBLM



Small Right
| MCBRS



Small Left
| MCBLS



Universal
Small
| MCBUS



Universal
Medium
| MCBUM



Universal
Large
| MCBUL

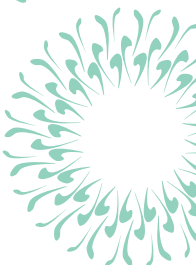
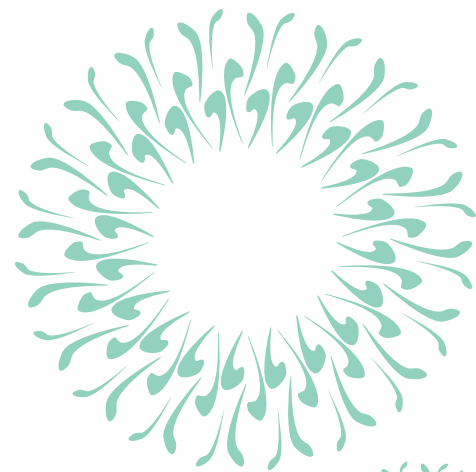

This family of ball burnishers is available in straight and angled forms. Straight designs provide direct, straight access with ease and visibility. The angled forms have long shanks for optimal reach and visibility of the working end.

MICROSURGICAL ABOU-RASS BURNISHERS



STRAIGHT



ANGLED





MICROSURGICAL RETRACTORS

ALLAM

A set of seven ergonomically-designed retractors with a common handle designed to reduce hand fatigue and enhance visibility. Contact ends facilitate placement over significant structures by retracting the entire flap and providing a large contact surface. Developed in conjunction with Dr. Charbel Allam.



Allam Retractor Palatal*
| SRTA01



Allam Retractor Mandibular*
| SRTA02



Allam Retractor Mandibular*
| SRTA03



Allam Retractor Universal*
| SRTA04



Allam Retractor Universal*
| SRTA05



Allam Retractor Maxillary Right*
| SRTA06



Allam Retractor Maxillary Left*
| SRTA07



Allam Retractor Handle
| TRMGRIF

ARENS

A wide and straight retractor set designed in conjunction with Dr. Donald Arens, the anterior retractor provides concurrent flap and lip retraction; while its posterior partner provides simultaneous flap and check retraction.



1 Anterior Arens Tissue Retractor
| TRARENS1



2 Posterior Arens Tissue Retractor
| TRARENS2

*Handle sold separately.



SURGICAL

Many of Hu-Friedy's surgical instruments are used for endodontic applications, especially when apical treatment is required. This includes needle holders, scissors, surgical curettes, periosteals and retractors. Here is a sample of some of our most popular surgical instruments used for endodontic treatments.

CURETTES

This double-ended curette is excellent for use in apical curettage. Available in round or oval designs, Hu-Friedy surgical curettes feature sharp working ends for efficient debridement or curettage.



Lucas Spoon Shape

No. 85

| CL856

Handle: #6

| CL85

Handle: #522 (not pictured)

NEEDLE HOLDERS

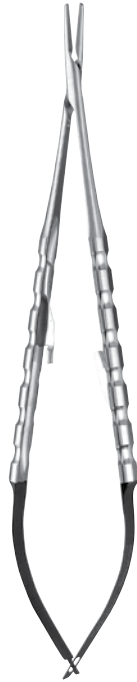

Micro Castroviejo
Straight Diamond
Dusted 7" (18 cm)*

| NHDPV

European handle design

Microsurgical needle holders have a lock to ensure that the needle is firmly secured. This allows the needle to be guided through coarse gingival tissue with controlled grip pressure.

Recommended suture sizes: 6-0, 7-0, 8-0.



Perma Sharp
Crile-Wood
6" (15 cm)*

| NH5038

Featuring a ratchet design and carbide inserts, this needle holder securely grasps the needle and provides enhanced comfort and control when suturing.

Recommended suture sizes: 3-0, 4-0, 5-0, 6-0.

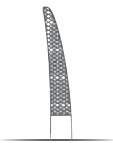

NEW!

Perma Sharp
Needle Holder,
Castroviejo Curved,
Round Handle
5" (14 cm)*

| NH5021RC

Combines a curved beak with the maneuverability and comfort provided by its round handle.

Recommended suture sizes: 5-0, 6-0, 7-0

Perma Sharp Needle Holders feature tungsten carbide inserts with a ground pyramidal profile to assure a firm, positive needle grip. Rotation of needle and/or slipping of suture material is virtually eliminated.

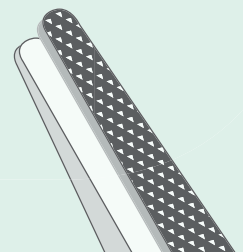

*Pictured at 50%.



PERIOSTEALS

Our periosteals are perfect for retracting and reflecting the mucoperiosteum during apical surgery.



9 Molt

| P9

Handle: #522

The P9 periosteal has small and large ends for reflection of the flap.



Buser

| PPBUSER

Handle options: #6, #522

A spade-paddle shaped periosteal for the reflection of tissue. The spear-end is used to initiate reflection of the papilla, and the paddle-end is used to continue apical retraction.

PERMA SHARP® SUTURES

Perma Sharp sutures are specifically designed for dentists, with a fine point geometry for smooth penetration and laser-drilled needles to help reduce tissue disruption. Manufactured from 300 Series Stainless Steel, the ideal alloy for dental suture needles, they provide a strong, sharp needle and increased ductile strength. Perma Sharp sutures ensure efficient and reliable soft tissue closure.

Here are some suggested sutures for apical applications:

4-0 Silk, Black C-19, 18"

| PSN734S

5-0 Polyester, D-14, 18"

| PSN7773L

5-0 Polypropylene, C-4, 18"

| PSN8245P

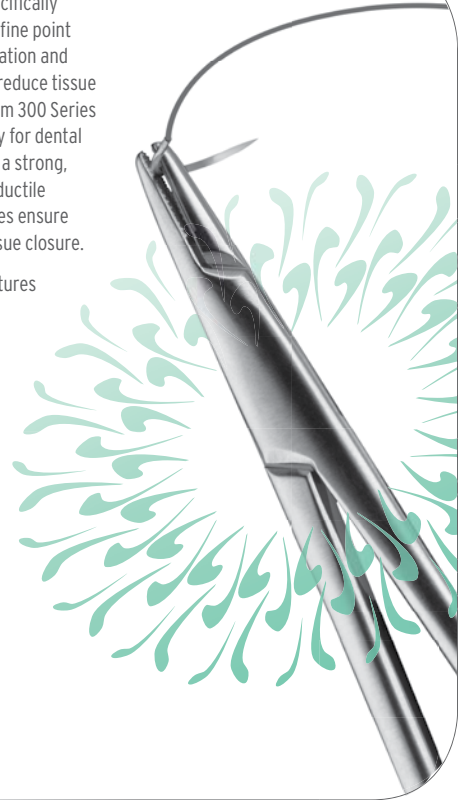

SUPER-CUT SCISSORS

Hu-Friedy scissors are available in Super-cut, Perma Sharp and Standard Series. Super-cut scissors feature a cutting blade which is honed and serrated to create razor sharpness, while the opposing blade is finished with fine serrations to avoid tissue slippage. Our extensive selection includes microsurgical, suture, Crown and Gold, bandage and general surgery scissors.



14 LaGrange Double-Curve 4-1/2" (11.5 cm)

| S14

1 serrated blade

| S14SC

Super-Cut with 1 serrated blade (pictured)



17 Iris Straight/Delicate 4-1/2" (11.5 cm)

| S17

1 serrated blade

| S17SC

Super-Cut with 1 serrated blade (pictured)



18 Iris Curved/Delicate 4-1/2" (11.5 cm)

| S18

1 serrated blade

| S18SC

Super-Cut with 1 serrated blade (pictured)



RETRACTORS

Hu-Friedy has a wide assortment of cheek and tissue retractors for reflecting mucoperiosteal flaps, cheeks, lips and tongue away from the surgical site.



Cawood-Minnesota Cheek/Tissue Retractor

| CRM2

The CRM2 is longer than a CRM and has more curvature on the handle design for enhanced comfort and control. The pointed, yet blunt working end allows for secure retraction while not obscuring the field of view.

Farabeuf Retractor Twin Set

| TRFB

Its straight lines and flat blades make this simple design easy to clean, sterilize and store. The twin set offers flexibility and versatility in selecting which retractor to use based on patient, treatment and clinician preference.

SCALPEL HANDLES

Our family of scalpel handles provide the maneuverability needed for effective blade cuts and incisions.



No. 5
| 10-130-05

A finely balanced, pen-like scalpel handle that easily rotates and maneuvers in difficult to reach areas with fingertip control.

Mini Blade Scalpel/Mirror Handle Stainless Steel

| SHDPV

Made of surgical grade stainless steel, its sleek design includes a built-in blade tightener for added convenience.

TISSUE PLIERS



Perma Sharp Tissue Pliers

| TP5072

Hu-Friedy tissue pliers are made from surgical grade stainless steel and are available in plain, 1x2 or multiple teeth. The TP5072 combines the advantages of "plain" inserts in limiting soft tissue trauma with the ergonomic benefits of a sculpted handle.



EXPLORERS

Hu-Friedy's endodontic explorers are made from a special blend of alloy which provides the flexibility, strength, tactile sensitivity and resilience clinicians need when exploring and assessing the treatment site. They are available in several double-ended designs and handles.

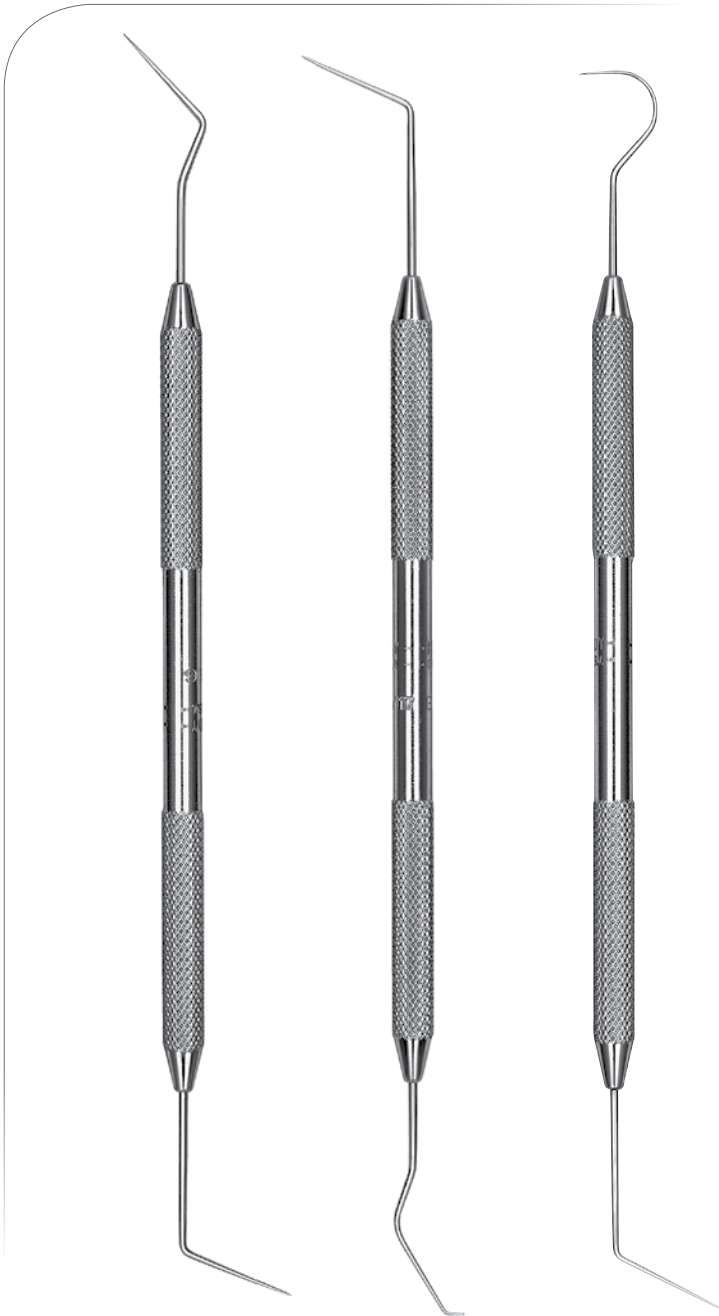
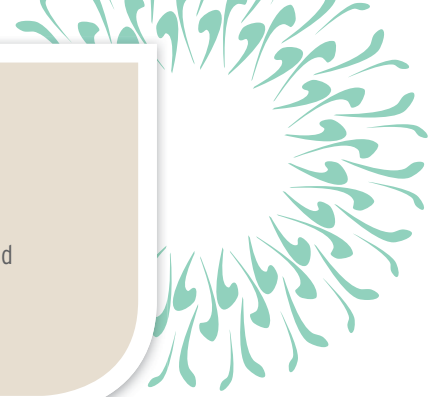

DG16
| EXDG16
Handle options: #6, #7, #31
| EXDG16T

DG16/17
| EXDG16/17
Handle: #31

DG16/23
| EXDG16/23
Handle: #31

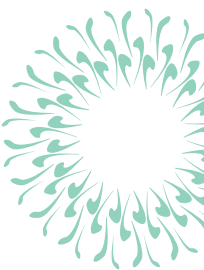

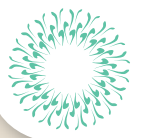

EXCAVATORS

Hu-Friedy's endodontic excavators feature extended-length shanks and are meticulously handcrafted from the highest grade stainless steel. They help the clinician access the pulp chamber for easy and efficient removal of dentin. The result is a superior clinical outcome and improved efficiency.

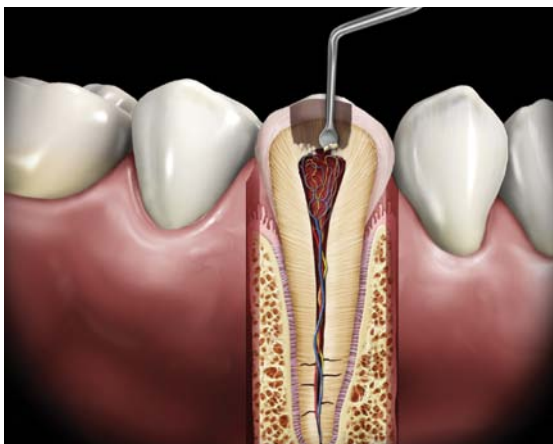

2 Glick
| EXCGL2

31L
| EXC31L
Handle options:
#6, #41

**31W
Oval Spoon**
| EXC31W
Handle options:
#6, #41

32L
| EXC32L
Handle options:
#6, #41

33L
| EXC33L
Handle options:
#6, #41

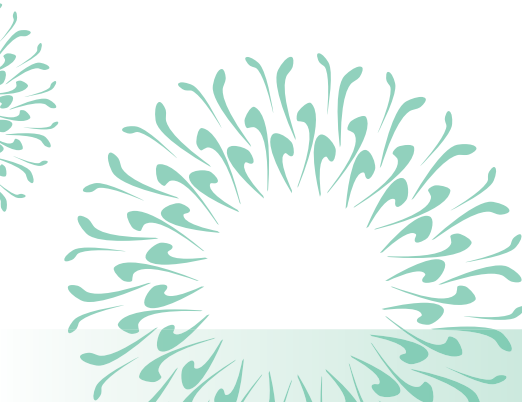



ENDODONTIC ACCESSORIES

In addition to critical procedural instruments such as spreaders, pluggers and rubber dam clamps, endodontic accessories, the "staples" of the office, are available to complete the line-up of Endo Essentials.

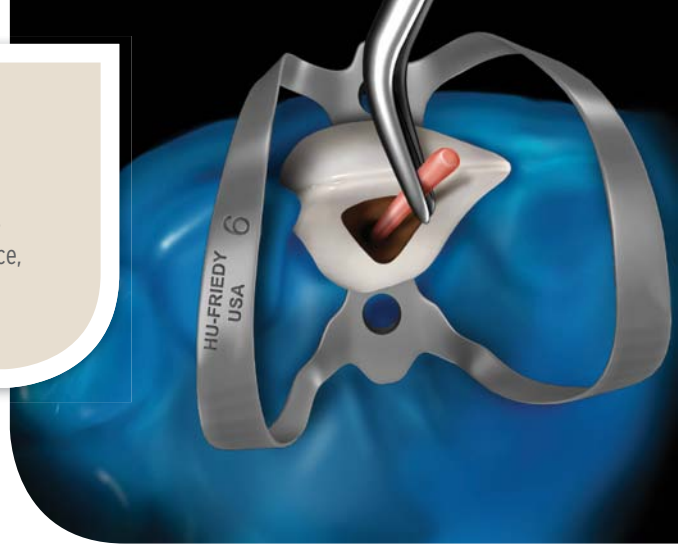

POST & SILVER POINT REMOVAL FORCEPS



Steiglitz Straight
5-1/2" (14 cm)*

| RFSTR



Steiglitz (Archer) 45°
5-1/4" (13-1/2 cm)*

| RF45



Steiglitz 90°
4-3/4" (12 cm)*

| RF90

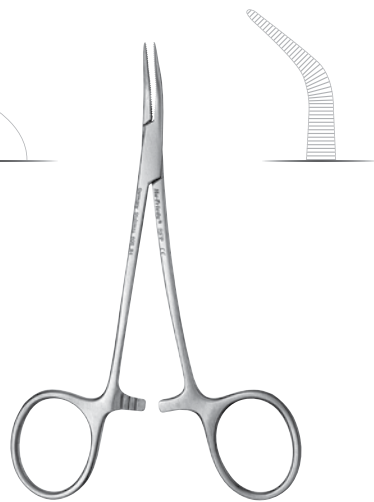

Peet 45°
4-3/4" (12 cm)*

| RFP



1 Mirror Handle
| MH6692K
With millimeter
scale.



6" Stainless
Steel Ruler
| CLR6



6-1/2"
(16-1/2 cm)
Locking Pliers
| EPL1

*Pictured at 50%.

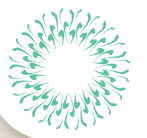

SPREADERS

Hu-Friedy manufactures a wide variety of spreaders, all handcrafted from the finest stainless steel to precise specifications. Choose from NiTi spreaders, ISO sized spreaders with color coded handles for easy identification, heat carriers, and a variety of other popular spreaders. Our spreaders help the clinician gain access into the most difficult canals for optimal compaction of filling material during lateral condensation.

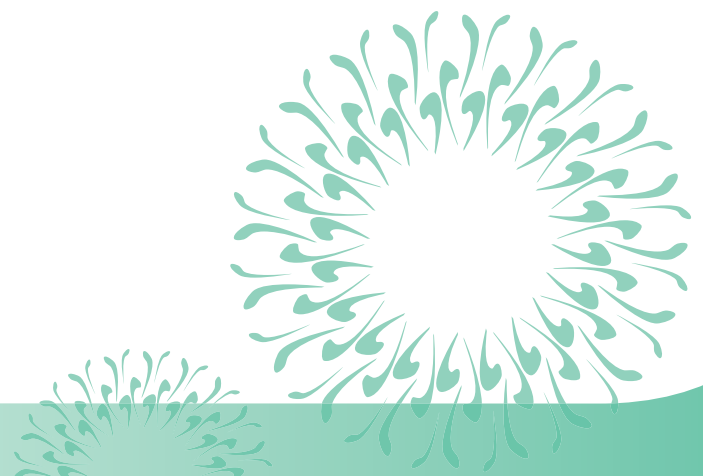
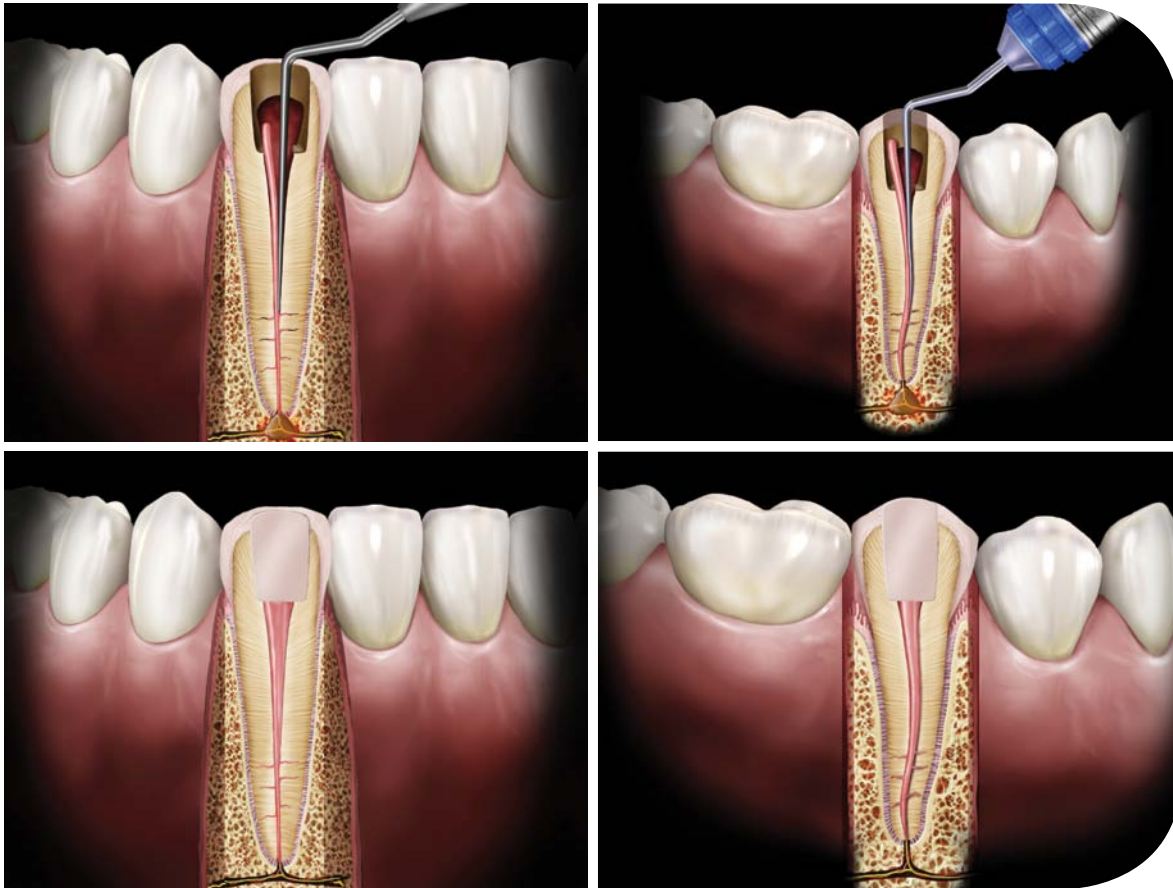



SPREADERS*

ISO SIZED SPREADERS*

ISO sized spreaders are color-coded for identification and convenience.



GP1
20 mm
| RCSGP1



1S Wakai
22 mm
| RCSW1S



2S Wakai
22 mm
| RCSW2S



ISO Size 30
24 mm
| RCS30



ISO Size 40
24 mm
| RCS40



D11 Standard
23 mm
| RCS D11



D11S Thin
23 mm
| RCS D11S



D11T Thinner
22 mm
| RCS D11T



D11TS Thinnest
21 mm
| RCS D11TS



ISO Size 50
28 mm
| RCS50



ISO Size 60
28 mm
| RCS60

ISO Spreaders have an ISO color-coded band on the handle for ease of identification during usage: #30-Blue, #40-Black, #50-Yellow, #60-Blue

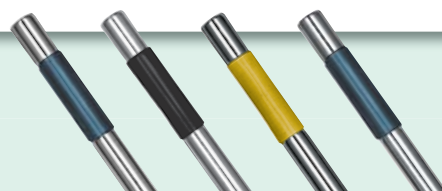

*D1=Diameter of instrument 1 mm from the tip. These measurements (i.e., .30) appear next to the tips of the instruments.



NICKEL TITANIUM ENDODONTIC SPREADERS*

Nickel Titanium, or NiTi, points provide these spreaders with extra flexibility and “memory” while the ergonomic, color-coded Satin Steel handles provide maximum comfort, control and easy identification. Choose from nine popular designs.

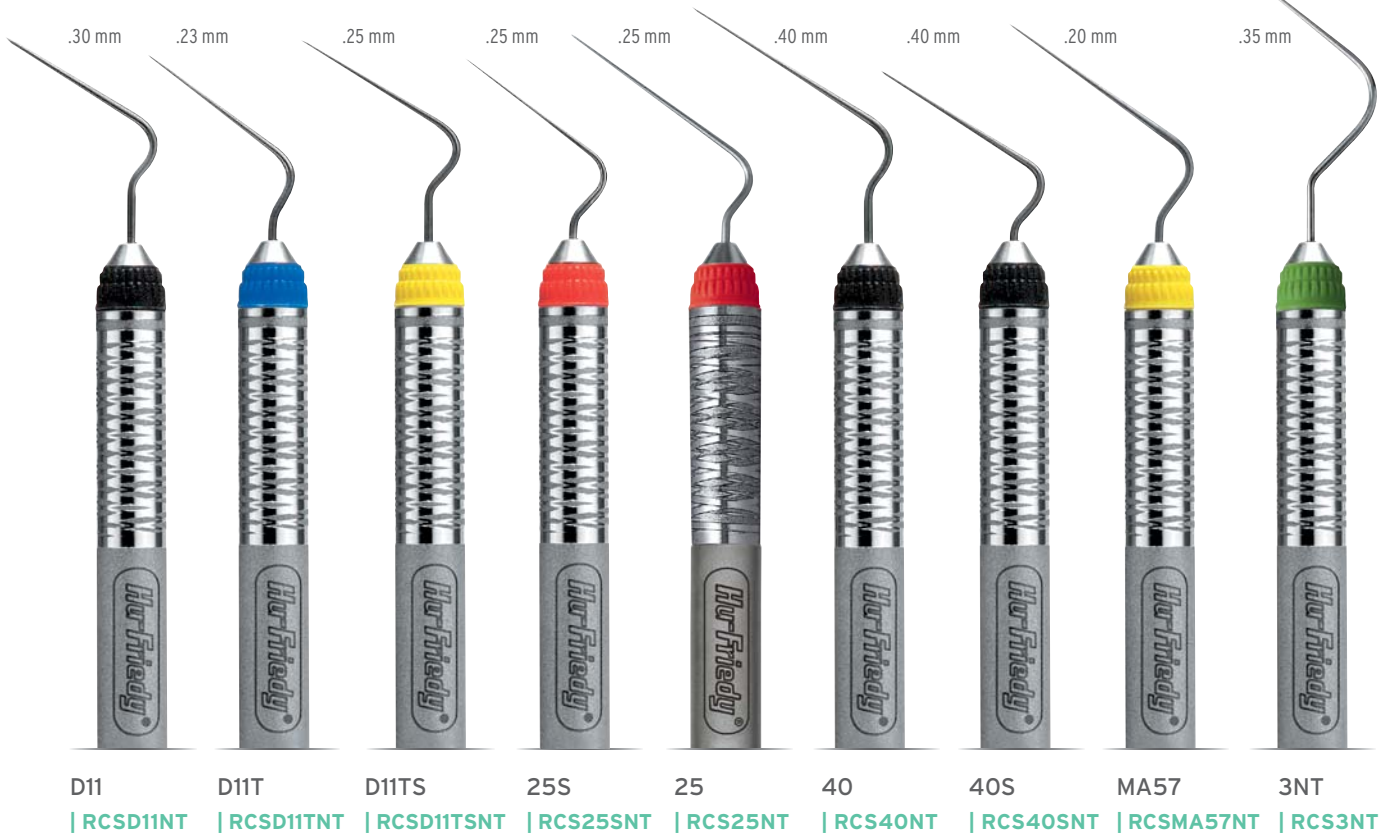

HEAT CARRIERS*

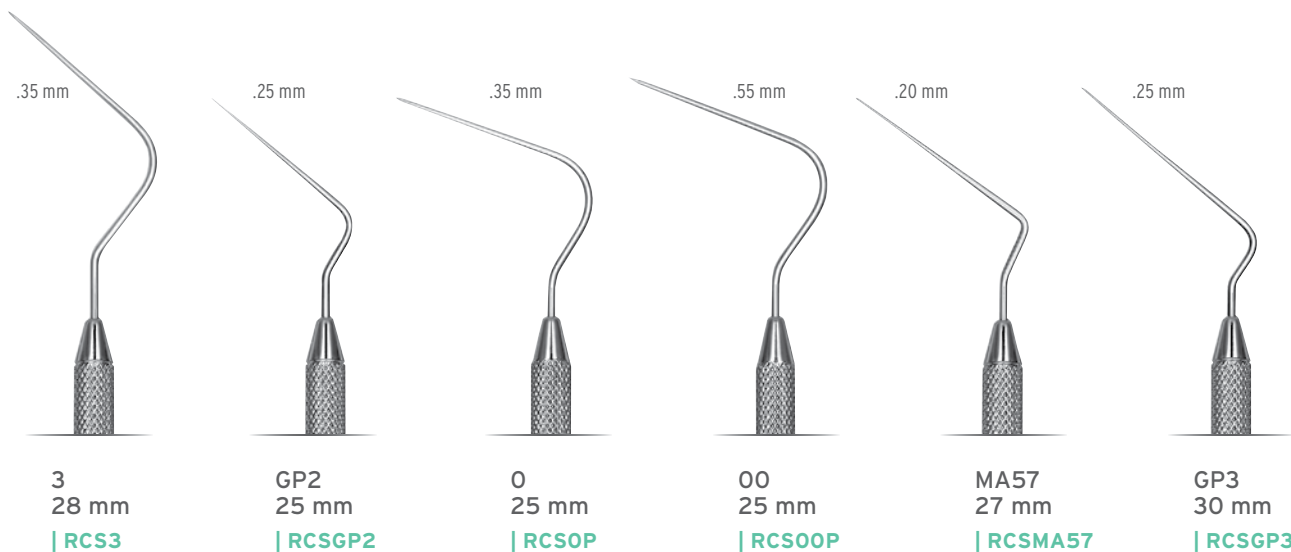

*D1=Diameter of instrument 1 mm from the tip. These measurements (i.e., .30) appear next to the tips of the instruments.



PLUGGERS

When performing vertical condensation, choose from ISO-sized anterior or posterior options, Machtou, the Glick Blade/Plugger or other options. These pluggers are handcrafted to exact specifications using the finest materials.

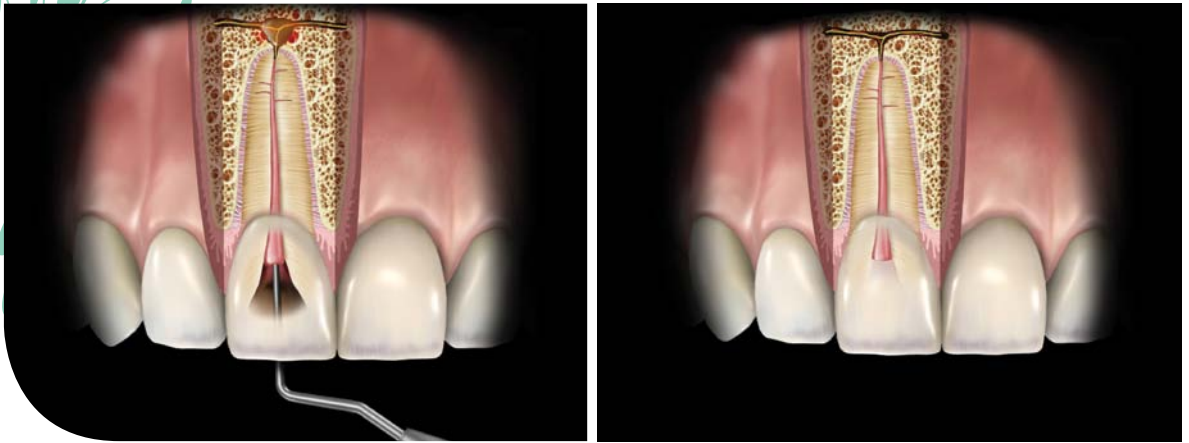
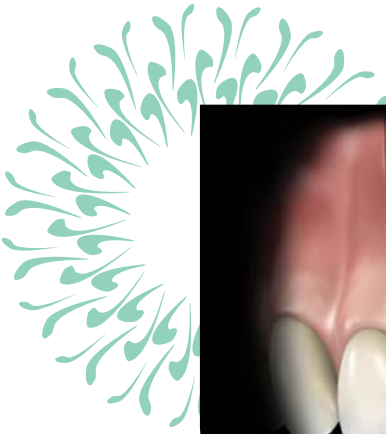

ISO SIZED PLUGGERS*

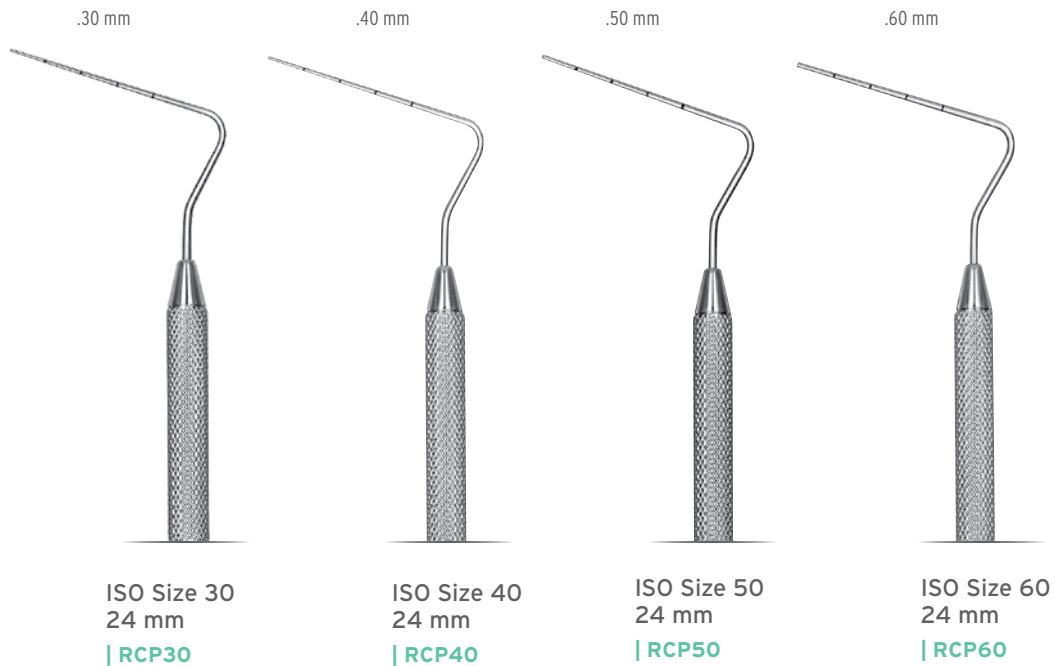

ISO Pluggers have an ISO color-coded band on the handle for ease of identification during usage: #30-Blue, #40-Black, #50-Yellow, #60-Blue.

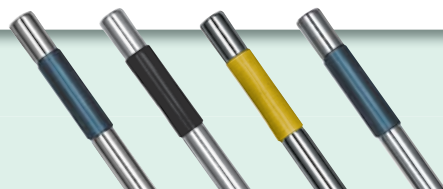

*DI=Diameter of instrument 1 mm from the tip. These measurements (i.e., .30) appear next to the tips of the instruments.

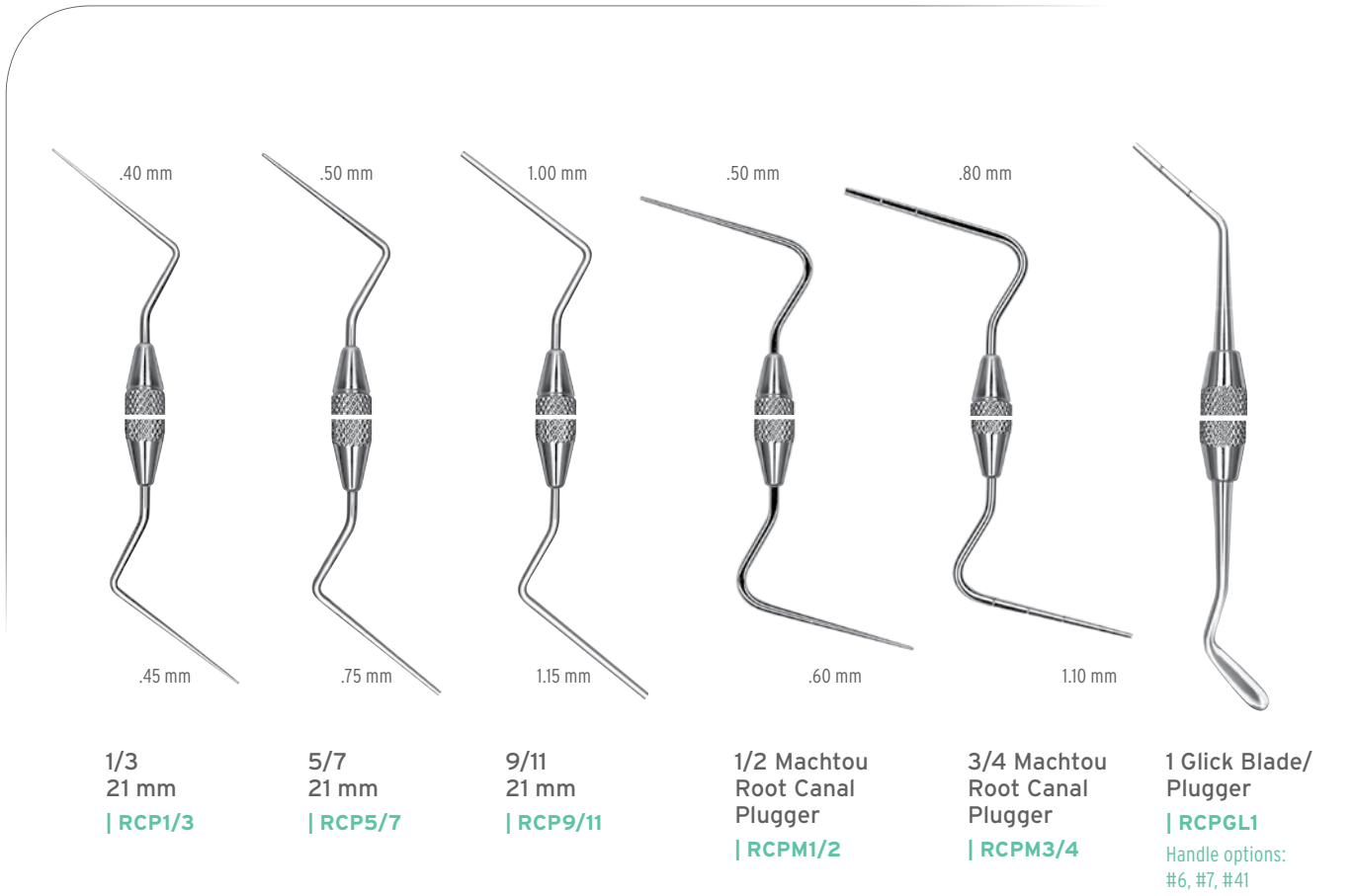

LUKS



*D1=Diameter of instrument 1 mm from the tip. These measurements (i.e., .30) appear next to the tips of the instruments. Marked at 5 mm intervals to assess penetration depth.



ANTERIOR

Anterior condensers are 7 mm longer than posterior condensers.

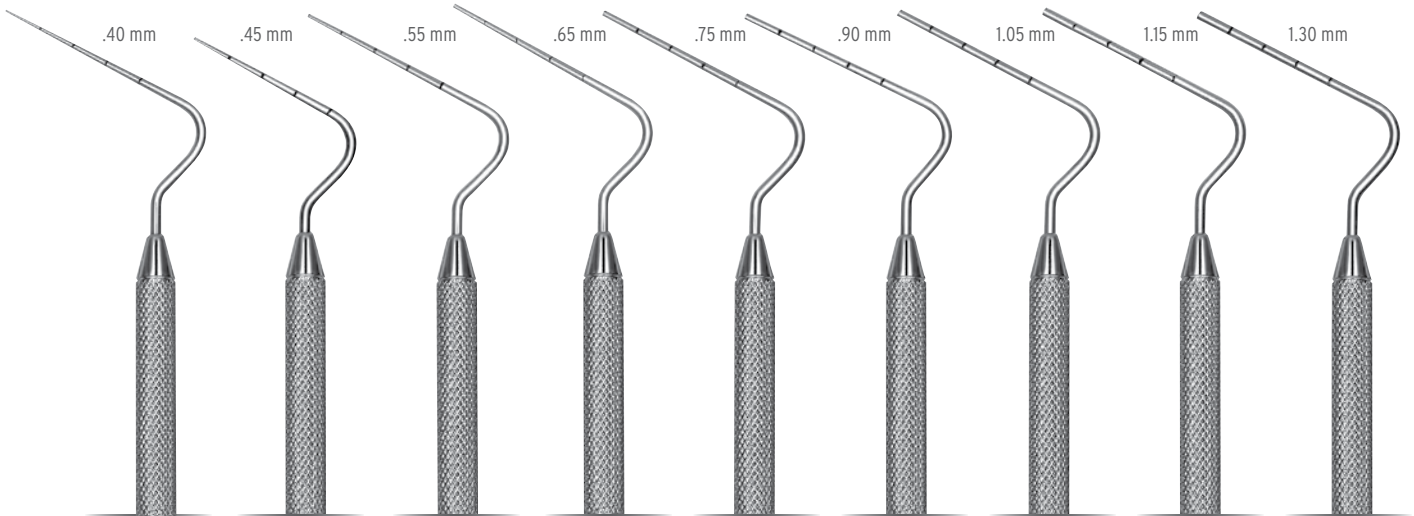

- | | | | | | | | | |
|------------------------|---------------------------------|------------------------|---------------------------------|--------------------------|----------------------------------|--------------------------|----------------------------------|--------------------------|
| 8A
29 mm
 RCP8A | 8-1/2A
29 mm
 RCP8-1/2 A | 9A
29 mm
 RCP9A | 9-1/2 A
29 mm
 RCP9-1/2A | 10A
29 mm
 RCP10A | 10-1/2A
29 mm
 RCP10-1/2A | 11A
29 mm
 RCP11A | 11-1/2A
29 mm
 RCP11-1/2A | 12A
29 mm
 RCP12A |
|------------------------|---------------------------------|------------------------|---------------------------------|--------------------------|----------------------------------|--------------------------|----------------------------------|--------------------------|

POSTERIOR

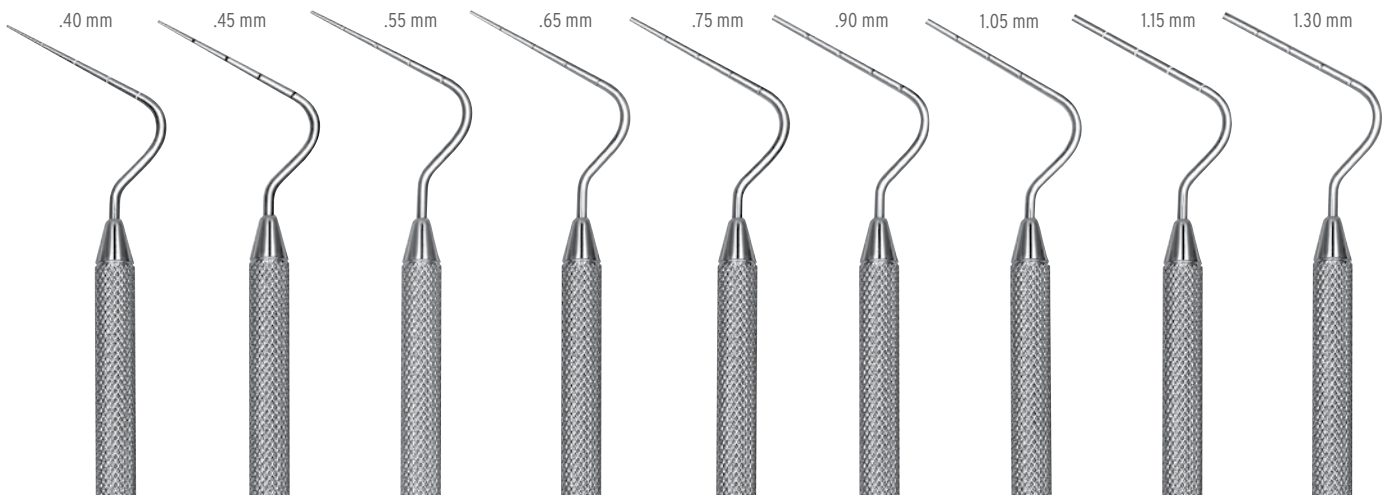

- | | | | | | | | | |
|----------------------|------------------------------|----------------------|------------------------------|------------------------|--------------------------------|------------------------|--------------------------------|------------------------|
| 8
22 mm
 RCP8 | 8-1/2
22 mm
 RCP8-1/2 | 9
22 mm
 RCP9 | 9-1/2
22 mm
 RCP9-1/2 | 10
22 mm
 RCP10 | 10-1/2
22 mm
 RCP10-1/2 | 11
22 mm
 RCP11 | 11-1/2
22 mm
 RCP11-1/2 | 12
22 mm
 RCP12 |
|----------------------|------------------------------|----------------------|------------------------------|------------------------|--------------------------------|------------------------|--------------------------------|------------------------|

*DI=Diameter of instrument 1 mm from the tip. These measurements (i.e., .40) appear next to the tips of the instruments. The terms "Condensers" and "Pluggers" are interchangeable.



RUBBER DAM CLAMP ACCESSORIES & KITS

Rubber Dam Clamp Organizing Board*

| RDCOB

Store, sterilize and organize with eight pegs that securely hold your clamps. Clamps not included.

Dimensions:
4.62" x 2.4" x .375"
(117 mm x 61 mm x 10 mm)

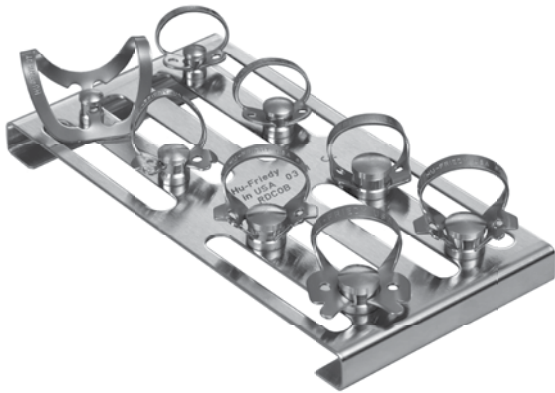

RUBBER DAM TEMPLATES

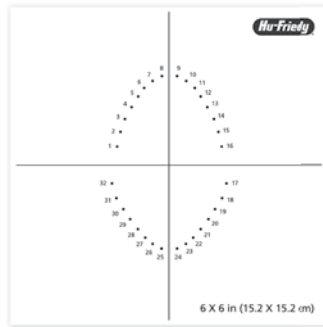

Universal Rubber Dam Template**

| RDTUNIV

Adult template shown.
Pedodontic template also included.

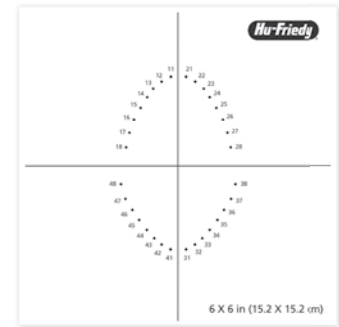

FDI Rubber Dam Template**

| RDTFDI

Adult template shown.
Pedodontic template also included.

RUBBER DAM CLAMP FORCEPS



4
7" (17-1/2 cm)**

| RDF4

Rubber Dam
Forceps
6-1/2" (17 cm)**

| RDF

RUBBER DAM FRAMES

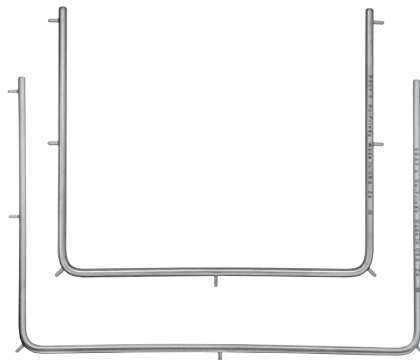

Rubber
Dam Frame
Child 5"
(13 cm)**

| RDCF5

Rubber
Dam Frame
Adult 6"
(15 cm)**

| RDAF6

RUBBER DAM PUNCHES



Rubber Dam
Punch
6-3/4" (16 cm)**

| RDP

Ainsworth
6-3/4" (17-1/2 cm)**

| RDPA

**Pictured at 50%.



RUBBER DAM KITS

Rubber Dam kits and collections give clinicians more choices, from an entire kit to basic clamp set-ups.

Rubber Dam Kit

| RDKIT

Basic items needed for rubber dam procedures conveniently packaged in a kit (also available individually).

Rubber Dam Clamp Forceps	RDF
Rubber Dam Punch	RDP
Rubber Dam Frame-Adult	RDAF6
Universal Rubber Dam Template	RDTUNIV
FDI Rubber Dam Template	RDTFDI
Rubber Dam Clamp Organizing Board	RDCOB
#0 Satin Steel Rubber Dam Clamp	RDCM0
#1 Satin Steel Rubber Dam Clamp	RDCM1
#2 Satin Steel Rubber Dam Clamp	RDCM2
#7 Satin Steel Rubber Dam Clamp	RDCM7
#8 Satin Steel Rubber Dam Clamp	RDCM8
#8A Satin Steel Rubber Dam Clamp	RDCM8A
#14A Satin Steel Rubber Dam Clamp	RDCM14A
#212 Satin Steel Rubber Dam Clamp	RDCM212

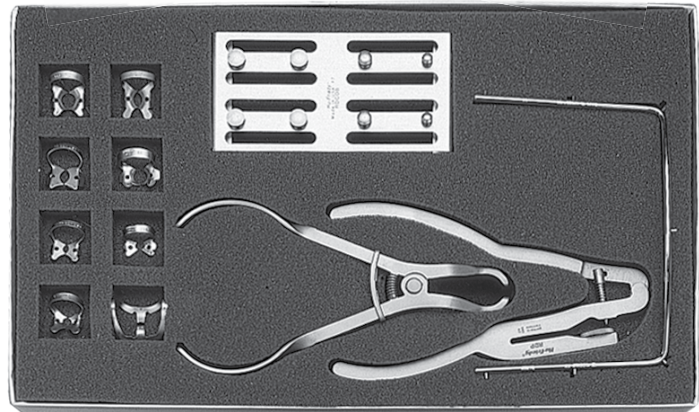
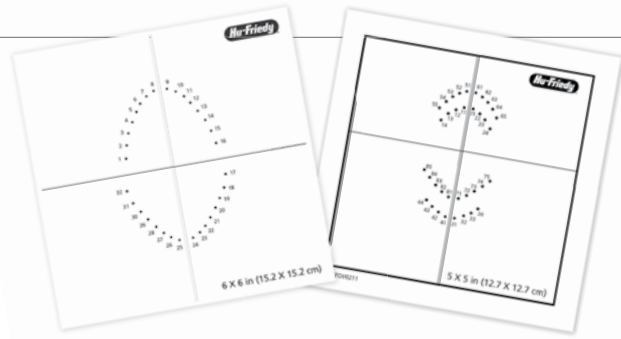

Rubber Dam Clamp 7 Pack

| RDCSET7

#00 Satin Steel Rubber Dam Clamp	RDCM00
#2 Satin Steel Rubber Dam Clamp	RDCM2
#7 Satin Steel Rubber Dam Clamp	RDCM7
#8 Satin Steel Rubber Dam Clamp	RDCM8
#8A Satin Steel Rubber Dam Clamp	RDCM8A
#9 Satin Steel Rubber Dam Clamp	RDCM9
#14A Satin Steel Rubber Dam Clamp	RDCM14A



Rubber Dam Clamp 8 Pack

| RDCSET

#0 Satin Steel Rubber Dam Clamp	RDCM0
#1 Satin Steel Rubber Dam Clamp	RDCM1
#14A Satin Steel Rubber Dam Clamp	RDCM14A
#2 Satin Steel Rubber Dam Clamp	RDCM2
#212 Satin Steel Rubber Dam Clamp	RDCM212
#7 Satin Steel Rubber Dam Clamp	RDCM7
#8 Satin Steel Rubber Dam Clamp	RDCM8
#8A Satin Steel Rubber Dam Clamp	RDCM8A

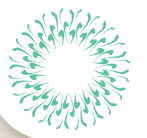

RUBBER DAM CLAMPS

Hu-Friedy rubber dam clamps are made in the USA from proprietary Satin Steel for corrosion resistance, superior strength, and a fine balance between flexibility and memory. The matte finish on all 48 styles absorbs and dissipates light instead of reflecting it back, so you can experience a comfortable field of vision that is easier on the eyes – to help you perform at your best.

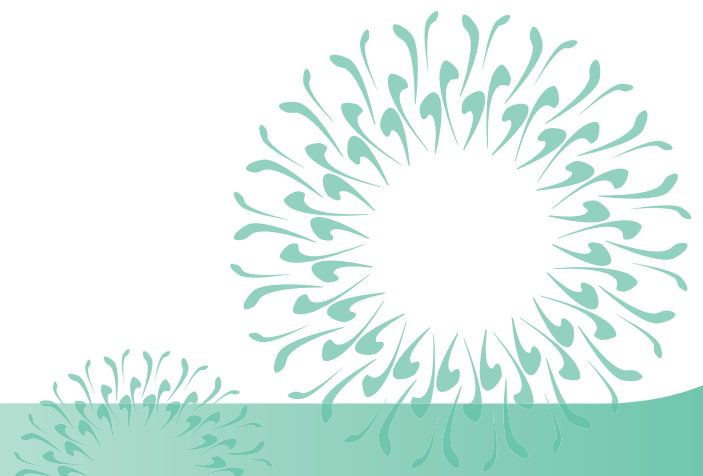



RUBBER DAM CLAMPS

A complete line of Satin Steel® Rubber Dam clamps for anterior, premolar and molar applications.

ANTERIOR

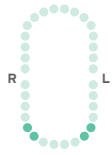

00

| **RDCM00**

Flat jaws and high bow for small lower canines and first premolars.

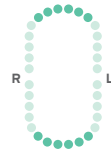

6

| **RDCM6**

Slightly offset jaws for labial caries on anterior teeth.

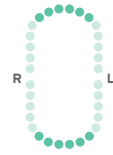

9

| **RDCM9**

Offset flat jaws and stiff bow for anterior teeth.

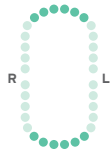

9S

| **RDCM9S**

Offset flat serrated jaws for anterior teeth.

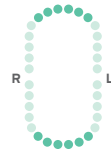

212

| **RDCM212**

Flat jaws for labial caries on anterior teeth.

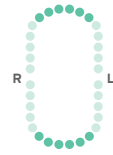

212SA

| **RDCM212SA**

Slightly offset staggered jaws for odd shaped anteriors.

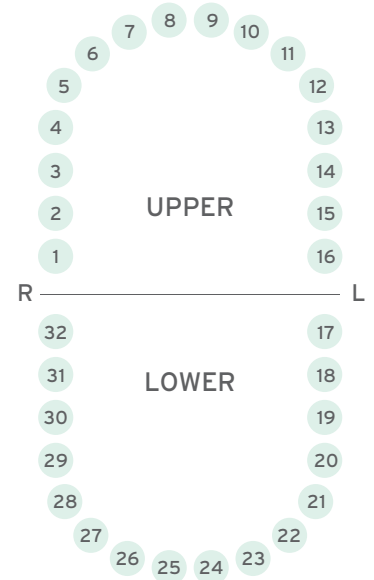

PREMOLARS

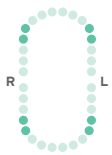

0

| **RDCM0**

Flat jaws and high bow for longer premolars.



1

| **RDCM1**

Slightly festooned jaws for upper premolars.

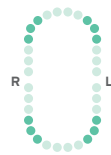

1A

| **RDCM1A**

Deeply festooned jaws for canines and premolars.



2

| **RDCM2**

Flat jaws for premolars.

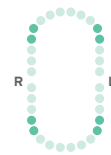

2A

| **RDCM2A**

Flat jaws for larger premolars.

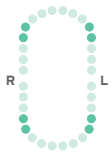

2AS

| **RDCM2AS**

Flat serrated jaws for larger premolars.

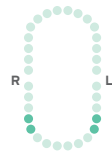

W2

| **RDCMW2**

Flat jaws for premolars.

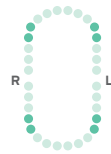

27N

| **RDCM27N**

Slightly festooned jaws for premolars.



29

| **RDCM29**

Flat jaws for lower premolars.



209

| **RDCM209**

Small, flat jaws with stiff bow for lower premolars.





MOLARS (GENERAL)



8A
| **RDCM8A**
Deeply festooned four-point jaws for molars.



8AD
| **RDCM8AD**
Deeply festooned jaws and extended bow for distal access to molars.



W8A
| **RDCMW8A**
Slightly festooned jaws for molars.



10
| **RDCM10**
Flat jaws designed for small upper left and lower right molars; paired with RDCM11.



11
| **RDCM11**
Flat jaws designed for small upper right and lower left molars; paired with RDCM10.

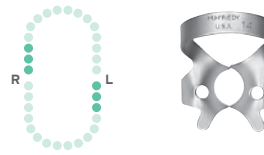

14
| **RDCM14**
Deeply festooned jaws for partially erupted or irregularly shaped molars.



14A
| **RDCM14A**
Deeply festooned jaws for partially erupted or irregularly shaped molars; larger than RDCM14.



W14A
| **RDCMW14A**
Deeply festooned jaws for partially erupted or irregularly shaped molars.



18
| **RDCM18**
Flat jaws and stiff bow for molars.



24
| **RDCM24**
Flat jaws for upper right and lower left molars; paired with RDCM25.



25
| **RDCM25**
Flat jaws for upper left and lower right molars; paired with RDCM24.



27
| **RDCM27**
Flat jaws for large molars.



56
| **RDCM56**
Slightly festooned jaws for large molars.

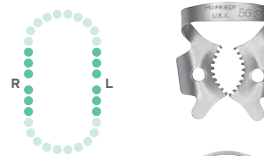

56S
| **RDCM56S**
Slightly festooned serrated jaws for large partially erupted or irregularly shaped molars.



RUBBER DAM CLAMPS

UPPER MOLARS



4
| RDCM4
Flat narrow jaws for small upper molars.



W4
| RDCMW4
Flat narrow jaws for small upper molars.



5
| RDCM5
Slightly festooned jaws for large upper molars.

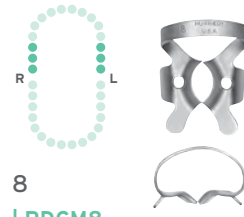

8
| RDCM8
Deeply festooned jaws for upper molars.



26N
| RDCM26N
Flat jaws for upper molars.



30
| RDCM30
Offset jaws for upper right molars; paired with RDCM31.

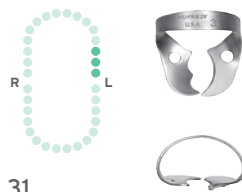

31
| RDCM31
Offset jaws for upper left molars; paired with RDCM30.

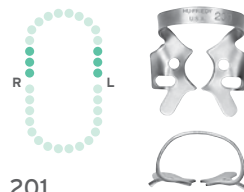

201
| RDCM201
Slightly festooned jaws for upper molars.

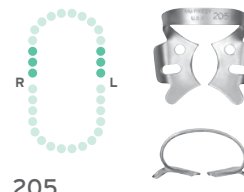

205
| RDCM205
Slightly festooned jaws for large upper molars.

LOWER MOLARS

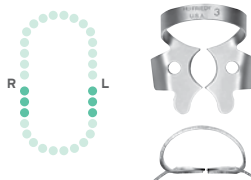

3
| RDCM3
Flat narrow jaws for small lower molars.



W3
| RDCMW3
Flat narrow jaws for small lower molars.

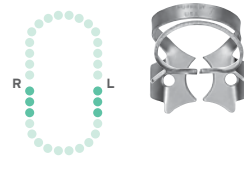

7
| RDCM7
Flat jaws for lower molars.

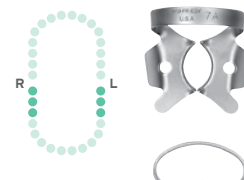

7A
| RDCM7A
Slightly reversed festooned jaws for large lower molars.

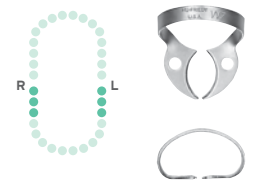

W7
| RDCMW7
Flat jaws for lower molars.

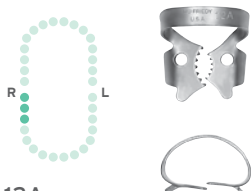

12A
| RDCM12A
Serrated offset jaws for lower right molars; paired with RDCM13A.

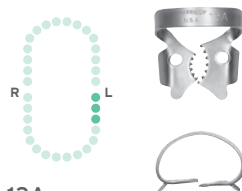

13A
| RDCM13A
Serrated offset jaws for lower left molars; paired with RDCM12A.

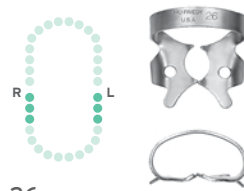

26
| RDCM26
Slightly reversed festooned jaws for small lower molars.

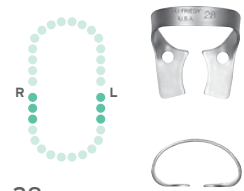

28
| RDCM28
Flat jaws for lower molars.



HU-FRIEDY'S INSTRUMENT MANAGEMENT SYSTEM CYCLE

Optimal infection control and prevention are facilitated by the use of tools that allow for improved efficiency and safety. Instrument integrity is further enhanced by the use of Hu-Friedy's Instrument Management System (IMS). IMS allows clinicians to move instruments from cleaning through chairside without touching or damaging the instruments.

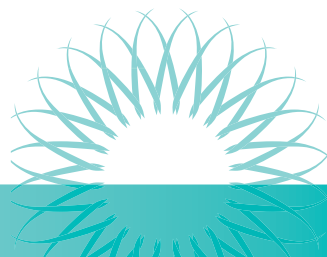
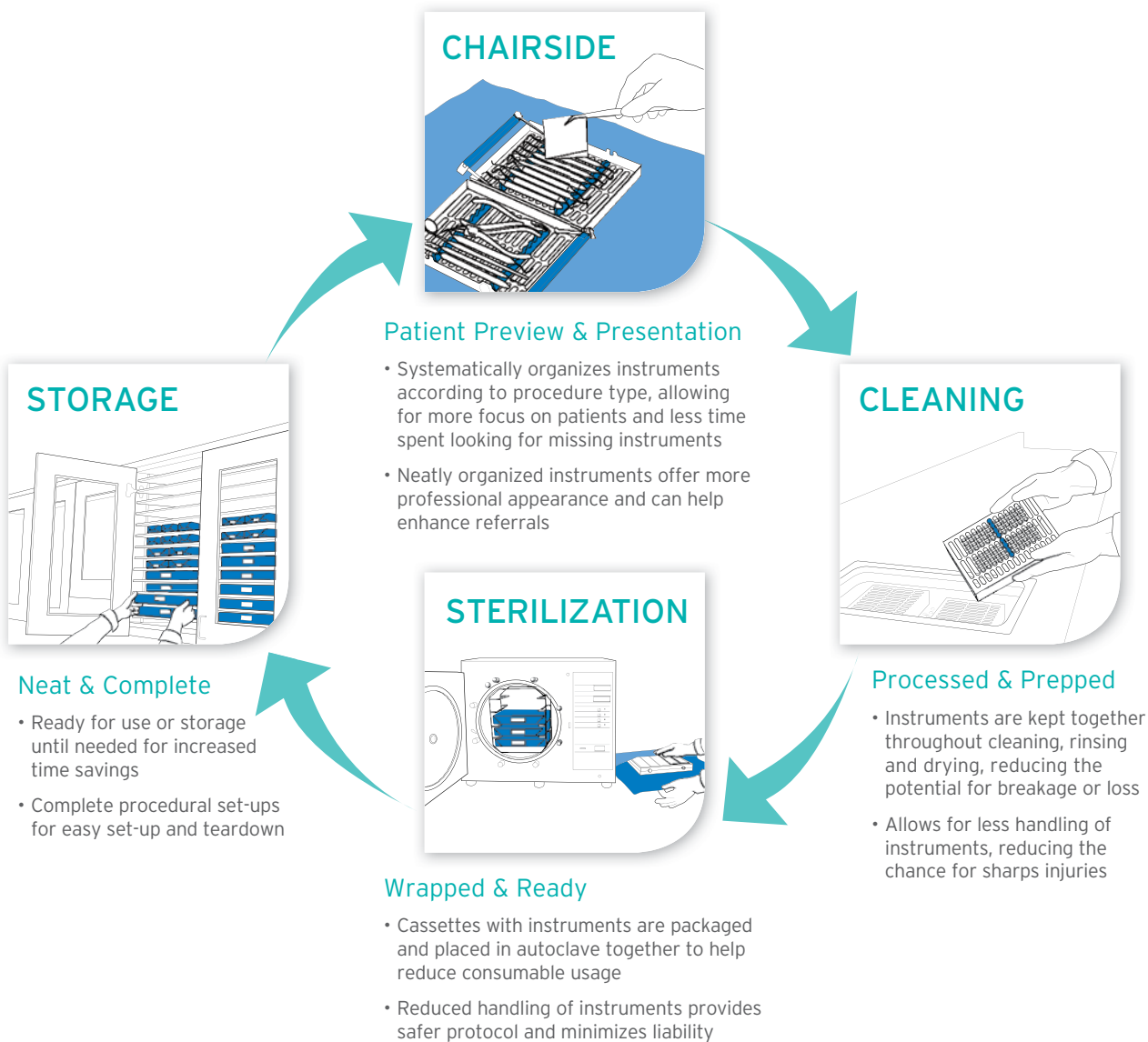
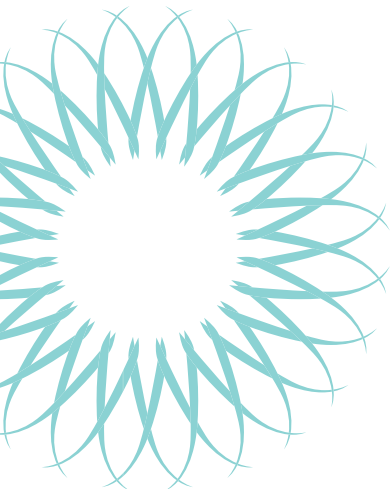



POINTS OF PERFORMANCE

Electropolish:

Provides a protective sheet against corrosion and a professional appearance

Durable Silicone Rails:

Specifically designed to safeguard instruments from damage during processing

Smooth Round Corners and Slotted Edges:

Increase drainage and reduce drying time

Efficient Hole Pattern:

Protects instruments from protrusion while allowing for enhanced cleaning and sterilization

Functional Accessory Area:

Includes built-in needle cap holder and winged syringe slot for optimized positioning (available in some models)

Positive Locking Mechanism:

Provides a visual indication that cassette is locked for safety

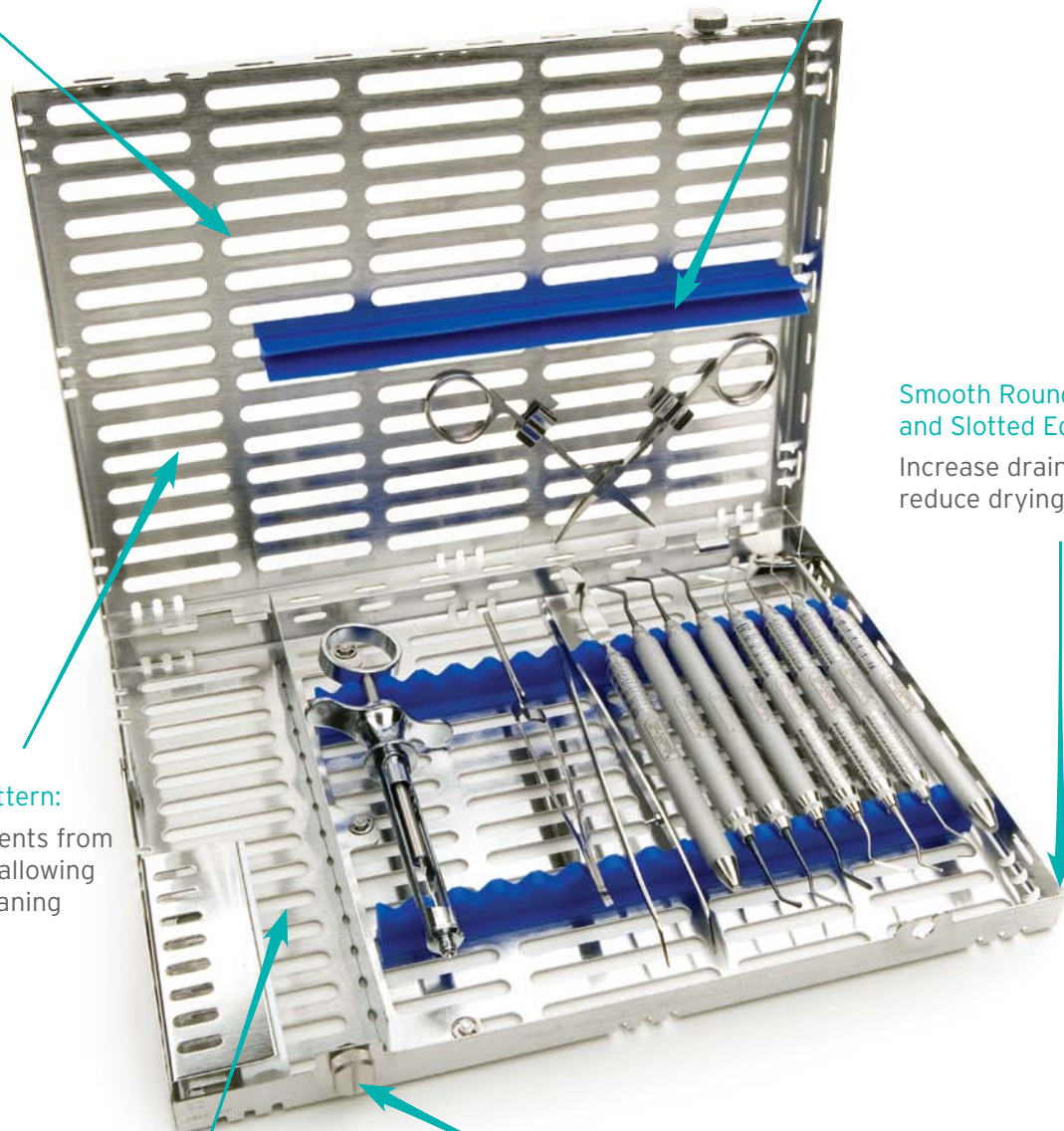

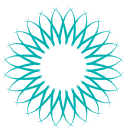

Signature Series® Cassettes are made of long-lasting, low-maintenance stainless steel. Soft, colored silicone rails securely hold instruments throughout the processing cycle. Available in over 100 different sizes, configurations and color options, and can be specialized to meet your needs.

IMS SIGNATURE SERIES CASSETTES

Exam Cassette – 5 Instruments

Holds 5 instruments.
Exterior Dimensions: 3" x 8" x 1.25"
(76 mm x 203 mm x 32 mm)

Red	IM6050
Gray	IM6051
White	IM6052
Orange	IM6053
Yellow	IM6055
Purple	IM6056
Blue	IM6058
Green	IM6059

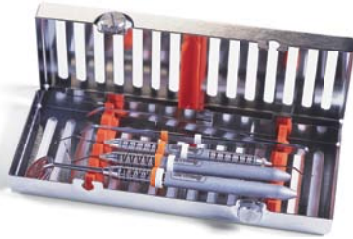

Small Cassette – 8 Instruments

Holds 8 instruments with an accessory area.
Exterior Dimensions: 5.5" x 8" x 1.25"
(140 mm x 203 mm x 32 mm)

Red	IM5080
Gray	IM5081
White	IM5082
Orange	IM5083
Yellow	IM5085
Purple	IM5086
Blue	IM5088
Green	IM5089



Signa-Stat Cassette – 12 Instruments

Holds 12 instruments with an accessory area. Fits in SciCan STATIM or the Midmark M3 autoclave.
Exterior Dimensions: 6.5" x 10.5" x 1.25"
(165 mm x 267 mm x 32 mm)

Red	IM8120
Gray	IM8121
White	IM8122
Orange	IM8123
Yellow	IM8125
Purple	IM8126
Blue	IM8128
Green	IM8129



Large Cassette – 16 Instruments

Holds 16 instruments with an accessory area.
Exterior Dimensions: 8" x 11" x 1.25"
(203 mm x 280 mm x 32 mm)

Red	IM4160
Gray	IM4161
White	IM4162
Orange	IM4163
Yellow	IM4165
Purple	IM4166
Blue	IM4168
Green	IM4169



Available in 8" x 10.5" x 1.25" size (IM416x0) to fit unique ultrasonic tanks and available in a 12 instrument version with a larger accessory area (IM412x).

IMS SIGNATURE SERIES CLIPS



Signature Series Air/Water Clip | IM1005

Designed to fit large or small Signature Series Cassettes, and can be permanently installed.



Signature Series Double-Decker Cassette Air/Water Clip | IM1006

Designed to fit Double-Decker Signature Series Cassette. Signature Series IMS clips can be permanently installed in your cassettes and can be permanently installed.



Signature Series Cassette Barcode Clip* | IMS-CABL

Dimensions: .75" x 2.26" x .067"
(19 mm x 57.4 mm x 1.7 mm)

Snap-on Barcode for outside of Cassettes. Contains laser marked barcode to be used for identification and tracking purposes. Compatible with standard barcode reader. Follows HIBC barcode standards. Lasermark tested to last more than 800 sterilization cycles.

*Pictured at 75%.



CASSETTE ACCESSORIES

IMS PARTS BOX

Designed to keep small items such as rubber dam clamps and matrix band retainers organized during the sterilization process.



IMS Large Parts Box

| **IMS-1273**

Exterior Dimensions: 3.5" x 1.12" x 1"
(89 mm x 29 mm x 25 mm)

IMS Small Parts Box

| **IMS-1271**

Exterior Dimensions: 1.56" x 1.25" x 1"
(40 mm x 32 mm x 25 mm)

IMS ENDODONTIC STAND

Hinged, double-lid stand holds endodontic files and reamers. Lid is etched with a ruler to measure stop positions easily from either direction.

IMS Endodontic Stand, Holds 24

| **IMS-1275**

Exterior Dimensions:
2.6" x 2.25" x 1.2"
(67 mm x 57 mm x 30 mm)

IMS Endodontic Stand, Holds 48

| **IMS-1275D**

Exterior Dimensions:
2.6" x 2.25" x 1.2"
(67 mm x 57 mm x 30 mm)

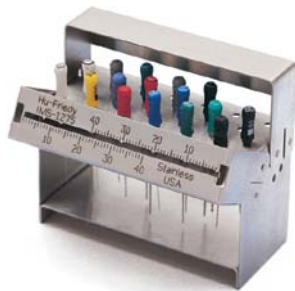

AIR WATER SYRINGE CLIPS

Designed to fit large or small Resin Cassettes. Clip holds air/water syringe tip securely in place throughout cleaning and sterilization.

IMS Large Resin Clip

| **IMS-1278**

IMS Small Resin Clip

| **IMS-1279**



IMS-1278

IMS BUR CUSHIONS

A hollow, rectangular, silicone base with a stainless steel lid that is designed to hold burs securely in place during cleaning and sterilization. Hollow design allows drainage and proper cleaning.



IMS Bur Cushion, Short Lid

| **IMS-1372S**

Holds 12 burs.
Exterior Dimensions:
3.3" x 1.3" x 0.9"
(84 mm x 33 mm x 22 mm)

IMS 1/2 Bur Cushion, Short Lid

| **IMS-1372SH**

Holds 6 burs.
Exterior Dimensions:
1.75" x 1.3" x 0.9"
(44 mm x 33 mm x 22 mm)

IMS Bur Cushion, Tall Lid

| **IMS-1372T**

Holds 12 burs.
Exterior Dimensions:
3.3" x 2.44" x 0.9"
(84 mm x 62 mm x 22 mm)

IMS 1/2 Bur Cushion, Tall Lid

| **IMS-1372TH**

Holds 6 burs.
Exterior Dimensions:
1.75" x 2.44" x 0.9"
(44 mm x 62 mm x 22 mm)

HINGED INSTRUMENT CLIPS

Secure scissors, hemostats and air/water syringe tips in lid of cassette.

Instrument Clips, 2-Hinged

| **IM1000**

Instrument Clips, 2-Hinged

| **IM1002**

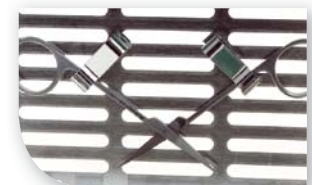

NEEDLE CAP HOLDER

2 Needle Cap Holders

| **IM1001**

Needle Cap Holders

| **IM1003**

Combination Pack**

| **IM1004**

**6 snap-in needle cap holders and 6 snap-in hinged instrument clips. Maintains cap in upright position for one-handed needle recapping.



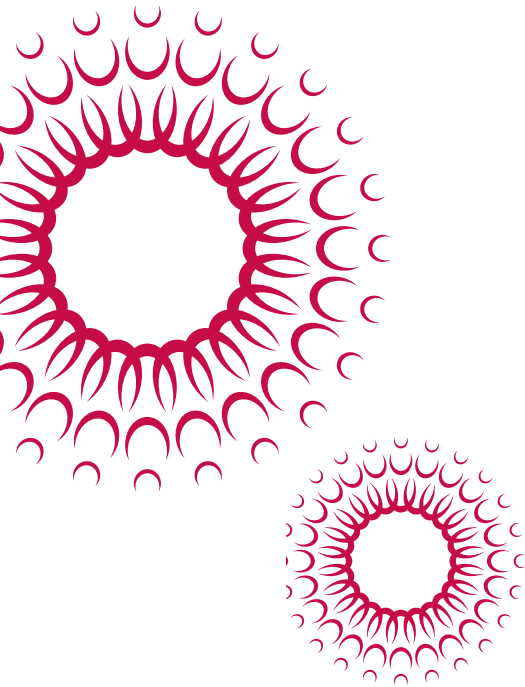

KEY OPINION LEADERS

Key Opinion Leaders' names are recognizable and their work is renowned. Hu-Friedy is honored to be in close association with Key Opinion Leaders, and it is a pleasure to present them to you as individuals full of life, character and vision. Hu-Friedy strives to supply our Key Opinion Leaders of all specialties with the most current offerings and information on our products and services. Being affiliated with outstanding dental professionals only helps to strengthen Hu-Friedy in our mission:

To improve lives through dentistry – smile after smile.

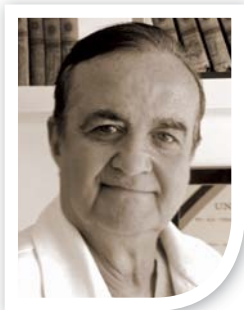

PROFESSOR MARWAN
ABOU-RASS

ABOU-RASS MICROSURGICAL ENDODONTIC KIT*



The instruments selected by Professor Marwan Abou-Rass for his new kit include those few that he relies on for clinical, education, and research activities. The entire collection of "MAR" instruments, which he uses in his work, can be found in the Microsurgical section of Endo Essentials.

A Professor Emeritus of the University of Southern California, Senior Academic Consultant at the Riyadh Military Hospital and General Director of the Prince Abdul- Rahman Advanced Dental Institute (PAADI), in Riyadh, Saudi Arabia, this Key Opinion Leader was instrumental in developing our apical product line.

16 Instrument Signature Series Cassette	IM4168 or IMDIN168
#9 Molt Periosteal Elevator	P9
#1 Henahan Retractor	TRH1
#3 Abou-Rass Endo Excavator DE	MAR-C3
#3 Abou-Rass Surgical Curette SE	MAR-SC3
#1 Abou-Rass Endo Explorer DE	MAR-EX1
#DG16/17 DE Endodontic Explorer	EXDG16/17
#1 Abou-Rass Straight Apical Condenser	MAR-SAC1
#1 Abou-Rass Angulated Apical Condenser	MAR-AAC1
#3 Abou-Rass Straight Burnisher	MAR-SB3
#3 Abou-Rass Burnisher SE	MAR-B3
#50L Fox Tissue Pliers w/Lock	TP50L
#1 Velvart Endo Satin Steel Micro Mirror	MMVEL1
#2 Velvart Endo Satin Steel Micro Mirror	MMVEL2
Metzenbaum Perma Sharp Scissors Cv/Bl	S5055
Crile-Wood Perma Sharp Needle Holder	NH5038
Halsey Perma Sharp N.H., Serrated	NH5037
#4 Kramer-Nevins DE Curette	SKN4

*Add cassette clips, to anchor instruments to the top of your cassette, and add accessories as needed.



KEY OPINION LEADER KITS



DR. RAINER HAHN



HAHN ENDODONTIC MICROSURGICAL KIT*

Large Signature Series, 16 Instrument Cassette – Blue, or Large Signature Series, 13 Instrument DIN Cassette – Blue	IM4168 or IMDIN138
Microsurgical Scissors, Straight, Castroviejo, 18 mm	SPV
Microsurgical Tissue Pliers, Curved, 18 mm	TPSLCOCMN
Microsurgical Needle Holder, Straight, Castroviejo	NHDPV
Microsurgical Scalpel Handle	SHDPV
Microsurgical Periosteal	PH26M
Spahr Periosteal (Optional)	PPSPAHR6
Mini Scalpel Blade	MB69
Labanca Periosteal, #6 Satin Steel Handle	PPLABANCA6



DR. NOAH CHIVIAN

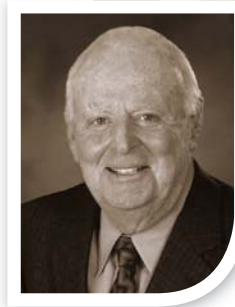

DR. DONALD ARENS



CHIVIAN-ARENS ENDODONTIC SURGERY KIT**

| ENDO-SXKIT

Large Signature Series 12 Instrument Cassette – Gray, or Large Signature Series, 13 Instrument DIN Cassette – Gray	IM4121 or IMDIN131
23/UNC15 University of North Carolina Expro	XP23/UNC15
1 Explorer	EXD1
5 Scalpel Handle	10-130-05
149 Periosteal	P149
2/4 Molt Surgical Curette	CM2/4
1 Hourigan Retractor	PH1
1 Anterior Arens Tissue Retractor	TRARENS1
2 Posterior Arens Tissue Retractor	TRARENS2
85 Lucas Surgical Curette	CL85
87 Lucas Surgical Curette	CL87
17/18 Indiana University Curette	SIU17/18
13/14 Columbia Curette	SC13/14
18 Iris Scissors Curved, Delicate	S18
Mathieu-Kocher Perma Sharp Needle Holder	NH5074

*Add cassette clips, to anchor instruments to the top of your cassette, and add accessories as needed. **Cassette sold separately.



DR. BERTRAND KHAYAT

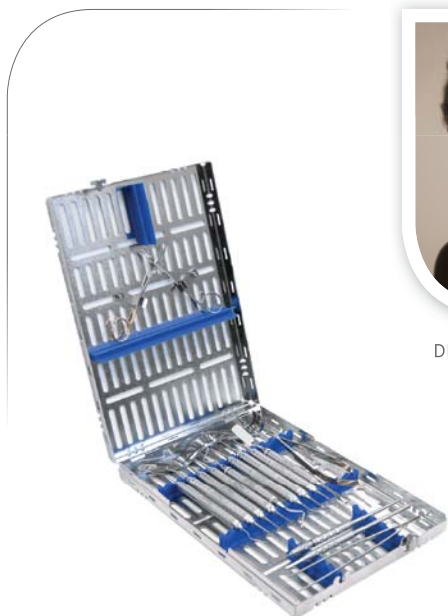

DR. PETER VELVART



KHAYAT ENDODONTIC SURGICAL KIT*

| **IMKHAYAT1** (Europe)

| **IMKHAYAT2** (North America)

Large Signature Series 20 Instrument Cassette – Blue, or Large Signature Series 18 Instrument DIN Cassette – Blue	IM4208 or IMDIN138S
Scalpel Handle	10-130-05E
Microsurgical Scalpel Handle, Stainless Steel	SHDPV
Micro Mirror Round, 2.5 mm	MM4
Khayat Apical Plugger, with Satin Steel Handle	PLGBK6
Khayat Instrument, with Satin Steel Handle	PF18ABK6
85 Lucas Surgical Curette, Spoon Shape, Short Satin Steel Handle	CL856
Velvart Condenser, with Satin Steel Handle	PLGVL56
NEW! Perma Sharp General Tissue Pliers, 6" (15 cm)	TP5072
PR-3 Prichard Periosteal, with Satin Steel Handle	PPR3S6
13/14 Columbia Curette, Universal with Satin Steel Handle	SC13/146
34/35 Jacquette Scaler, Miniature, Posterior with Satin Steel Handle	SJ34/356
89/92 Carver Discoid-Cleoids, with Satin Steel Handle	CD89/926
DG 16/17 Endodontic Explorer, with Satin Steel Handle	EXDG16/176
Cawood-Minnesota Retractor	CRM2
NEW! Perma Sharp Needle Holder, Castroviejo Curved, Round Handle, 5.5" (14 cm)	NH5021RC
14 LaGrange Double-Curved Super Cut Scissors	S14SC

VELVART ENDODONTIC MICROSURGICAL KIT*

Large Signature Series 16 Instrument Cassette – Blue, or Large Signature Series 13 Instrument DIN Cassette – Blue	IM4168 or IMDIN138
Microsurgical Mirror, 3 mm	MM4
Microsurgical Mirror, 5 mm	MM5
Microsurgical Mirror, 7 mm x 2 mm	MM7
Microsurgical Mirror, 9 mm x 3 mm	MM8
Microsurgical Needle Holder, 18 cm, Straight	NHDPV
Microsurgical Mirror Handle/Micro Scalpel Handle	SHDPV
Mini Scalpel Blade, 12 per pack	MB67
Mini Scalpel Blade, 12 per pack	MB69
Micro Surgical Scissors, 18 cm	SPV
Micro Tissue Pliers, 18 cm, Straight	TPDAPV
Micro Tissue Pliers, 18 cm, Angled	TPDSCPV
Micro Tissue Pliers, 18 cm, Straight	TPDSSPV

*Add cassette clips, to anchor instruments to the top of your cassette, and add accessories as needed.



KEY OPINION LEADER KITS



PROFESSOR DR. PIERRE MACHTOU

MACHTOU ENDODONTIC PRE-TREATMENT KIT*

Large Signature Series 16 Instrument Cassette – Blue, or Large Signature Series 16 Instrument DIN Cassette – Blue	IM4168 or IMDIN168
IMS Signature Cassette Clips, 2	I1000
IMS Bur Cushion, Short Lid, Holds 12	IMS-1372S
Articulation Paper Pliers	APF2E
Hollenbach Carver, #6 Satin Steel Handle	CVHL3S6
Universal Pliers	DPU17
Endodontic Excavator, #6 Satin Steel Handle	EXC32L6
Explorer, #30 Handle, 12.5 mm	EXS6XL
Kelly Hemostat, 14 mm	H1
5 Front Surface Mouth Mirror	MIR5
#6 Satin Steel European Mirror Handle	MHE6
Qulix® UNC Color-coded Probe, #6 Satin Steel Handle	PCPUNC156
Loesche 2 Composite/Filling, #6 Satin Steel Handle	PFIGML26
Rubber Dam Frame, Adult	RDAF6
#1 Rubber Dam Clamp	RDCM1
#212 Rubber Dam Clamp	RDCM212
#26N Rubber Dam Clamp	RDCM26N
#4 Rubber Dam Clamp	RDCM4
#8 Rubber Dam Clamp	RDCM8
#9 Rubber Dam Clamp	RDCM9
#W8A Rubber Dam Clamp	RDCMW8A
Rubber Dam Clamp Forceps	RDF4
Iris Scissors, Straight, Delicate, 11.5 cm	S17
204S Sickie Scaler, #6 Satin Steel Handle	S204SD6
Anesthetic Syringe, Type CW	SYRCWE

MACHTOU ENDODONTIC TREATMENT KIT*

Large Signature Series 16 Instrument Cassette – Blue or Large Signature Series 16 Instrument DIN Cassette – Blue	IM4168 or IMDIN168
IMS Signature Series Large Parts Box	M-1273
Cement Spatula	CSA6
1 Perry Dressing Pliers	DPI
DG16 Explorer, #7 Satin Steel Colours Handle	EXDG167
5 Front Surface Mouth Mirror, Simple Stem	M5C
#6 Satin Steel European Mirror Handle	MHE6
10 Root Canal Plugger	RCP10
11 Root Canal Plugger	RCP11
8 Root Canal Plugger	RCP8
9 Root Canal Plugger	RCP9
1/2 Machtou Root Canal Plugger	RCPM1/2
3/4 Machtou Root Canal Plugger	RCPM3/4
11T Spreader	RCSD11T
Iris Scissors, Straight, Delicate, 11.5 cm	S17

*Add cassette clips, to anchor instruments to the top of your cassette, and add accessories as needed.



DR. THOMAS VON ARX



VON ARX APICAL MICROSURGERY INSTRUMENT KIT*

Large Signature Series 20 Instrument Cassette – Blue, or Large Signature Series 18 Instrument DIN Cassette – Blue	IM4208 or IMDIN138S
Signature Series Cassette Clips, 2	I1000
Scalpel Handle	10-130-05E
#15C Scalpel Blades	10-256-15
84 Lucas Surgical Curette, #6 Satin Steel Handle	CL846
86 Lucas Surgical Curette, #6 Satin Steel Handle	CL866
32L Excavator, #6 Satin Steel Handle	EXC32L6
E1 Excavator (12-9-15), #6 Satin Steel Handle	EXCE16
Halsted-Mosquito Hemostat, Straight, 4.72" (12 cm)	H4
Abou-Rass Microsurgical Excavator	MAR-C1
Apical Burnisher/Plugger, Large, Left	MCBLL
Apical Burnisher/Plugger, Medium, Left	MCBLM
Apical Burnisher/Plugger, Small, Left	MCBLS
Apical Burnisher/Plugger, Large, Right	MCBRL
Apical Burnisher, Medium, Right	MCBRM
Apical Burnisher, Small, Right	MCBRS
Microsurgical Explorer	MEX16
Markel Adult Mouth Prop	MP54
Perma Sharp Needle Holder Castroviejo, Straight	NH5024
Perma Sharp Needle Holder Crile-Wood	NH5038
Colorvue® Probe Tips, 12 pcs (3-6-9-12)	PCV12PT
Colorvue Satin Steel Handle	PH6
Buser Periosteal, #6 Satin Steel Handle	PPBUSER6
3/9A Prichard Periosteal, #6 Satin Steel Handle	PPR3/9A6
Microsurgical Scissors, Curved, Titanium	STMBH
8A XTS® Satin Steel Composite Filling Instrument	TNPFI8A
Tissue Pliers Micro, Straight, Titanium	TPASTMBH

ENDODONTIC SIGNATURE SERIES KIT**

Large Signature Series 12 Instrument Cassette – Gray, or Large Signature Series, 13 Instrument DIN Cassette – Gray	IM4121 or IMDIN131
#6 Satin Steel Mirror Handle	MH6
4 Front Surface Mouth Mirror	MIR4
DG16 Endo Explorer, #6 Satin Steel Handle	EXDG166
1 Locking Endo Pliers	EPL1
31L Endo Excavator, #6 Satin Steel Handle	EXC31L6
D11 Nickel Titanium Endo Spreader	RCSD11NT
1/3 Endo Plugger	RCP1/3
5/7 Endo Plugger	RCP5/7
9/11 Endo Plugger	RCP9/11
1 Glick Blade/Endo Plugger	RCPGL1
Miller Articulating Paper Forceps	APF2
CW Aspirating Anesthetic Syringe	SYRCW
Rubber Dam Forceps	RDF
#1 Rubber Dam Clamp	RDCM1
#2 Rubber Dam Clamp	RCDM2
#9 Rubber Dam Clamp	RDCM9
#26N Rubber Dam Clamp	RDCM26N
Endo Stand, Holds 24 Files and Reamers	IMS-1275
Small Parts Box	IMS-1271
Bur Cushion Short Lid, Holds 12	IMS-1372S
A/W Syringe Tip Clip	IM1005

ENDODONTIC SIGNATURE SERIES KIT 2**

Large Signature Series 12 Instrument Cassette – Gray, or Large Signature Series, 13 Instrument DIN Cassette – Gray	IM4121 or IMDIN131
#6 Satin Steel Mirror Handle	MH6
4 Front Surface Mouth Mirror	MIR4
5 Explorer	EXD5
CP-12 Probe	PCP12
DG16 Endo Explorer	EXDG16
1 Locking Endo Pliers	EPL1
31L Endo Excavator	EXC31L
D11T Endo Spreader	RCSD11T
5/7 Endo Plugger	RCP5/7
1 Glick Blade/Endo Plugger	RCPGL1
Bur Cushion	IMS-1372S
Small Parts Box	IMS-1271A18
#1 Rubber Dam Clamp	RDCM1
#2 Rubber Dam Clamp	RCDM2
#9 Rubber Dam Clamp	RDCM9
#26N Rubber Dam Clamp	RDCM26N
Rubber Dam Forceps	RDF
Miller Articulating Paper Forceps	APF2

*Add cassette clips, to anchor instruments to the top of your cassette, and add accessories as needed.
 **Add a RDP or RDPA Rubber Dam Punch to your kit, and additional clamps such as the RDCM12A – paired with RDCM13A.

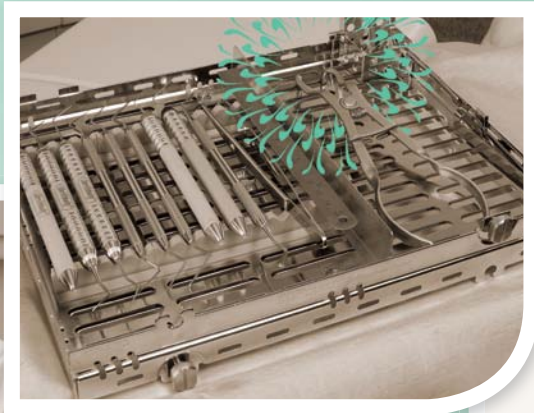

For more information about Hu-Friedy's Total Solutions visit **HU-FRIEDY.COM**

FPO BOX

PERIODONTAL	RESTORATIVE	ORTHODONTIC	INSTRUMENT MANAGEMENT	ENDODONTIC	SURGICAL	ULTRASONIC SCALING

Hu-Friedy Mfg. Co., LLC: 3232 N. Rockwell St. | Chicago, IL 60618 | USA
Telephone: 1-800-Hu-Friedy (1-773-975-6100) | Website: Hu-Friedy.com

©2012 Hu-Friedy Mfg. Co., LLC. All rights reserved. The contents of this Product Catalog including, but not limited to, all text, photographs and graphics, are the sole and exclusive property of Hu-Friedy Mfg. Co., LLC and may not be copied, reproduced or distributed without prior written permission. HF-654/1212

